



YAMAHA

1975 Ty80 Owners Service Manual

www.Yamaha-Enduros.com

Manual Donated by user PDXTYIST

YAMAHA

TY80

1973-1975?

FOREWORD

Yamaha's TY80A Trials is a completely new model designed solely for the rigors of Trials competition. Production is limited. Each unit is assembled and checked according to the same rigorous principles as our championship road racing and motocross models.

This Owner's Service Manual is included with your TY80A to provide basic information for operation and maintenance. Additional information regarding major repairs, such as crankcase disassembly, can be found within the GT80A Service Manual and various other information and training manuals available from your Authorized Yamaha Dealer.

YAMAHA MOTOR COMPANY, LTD.
EXPORT SERVICE DIVISION
IWATA, JAPAN

TABLE OF CONTENTS

I. MACHINE IDENTIFICATION	5
II. SPECIFICATION	6
III. MAINTENANCE SPECIFICATIONS	10
IV. NOMENCLATURE	12
V. BASIC INSTRUCTIONS	14
CONTROL FUNCTIONS	14
GASOLINE AND OIL	18
VI. OPERATION	21
PRE-OPERATION CHECK LIST	22
STARTING AND OPERATION	23
BREAK-IN PROCEDURE	25
VII. MECHANICAL ADJUSTMENTS	26
BRAKES	26
CLUTCH	27
CHAIN	28
CARBURETOR	29
AUTOLUBE	30
SPARK PLUG	33
IGNITION TIMING	34

VIII. MAINTENANCE AND MINOR REPAIRS	37
INTERVALS CHAFTS AND SPECIAL TOOLS	38
AIR FILTER	44
CARBURETION AND REED VALVE	46
TOP END AND MUFFLER	58
IGNITION	72
CLUTCH, SHIFTER AND KICK STARTER	76
DRIVE SPROCKETS AND CHAIN	92
CABLES	95
IX. CHASSIS AND SUSPENSION	
WHEELS AND TIRES	98
BRAKES	104
FRONT FORK	108
REAR SHOCKS AND SWING ARM	114
FRAME AND MISCELLANEOUS	115
X. ELECTRICAL SYSTEM	
GENERAL INFORMATION AND SCHEMATICS	115
IGNITION SYSTEM AND COMPONENT PARTS	118
LIGHTING, SWITCHES AND MISCELLANEOUS	
XI. MISCELLANEOUS	
CONVERSION TABLES	121
CLEANING AND STORAGE	124
CABLE ROUTING	126
WARRANTY	129

CHAPTER I MACHINE IDENTIFICATION

MACHINE IDENTIFICATION

~~0001~~ # 451 = 7480

The frame serial number is located on the right-hand side of the headstock assembly. The first three digits identify the model. This is followed by a dash. The remaining digits identify the production number of the unit. Yamaha production begins -000101.

The engine serial number is located on a raised boss on the upper left-hand side of the engine. Engine identification follows the same code as frame identification.

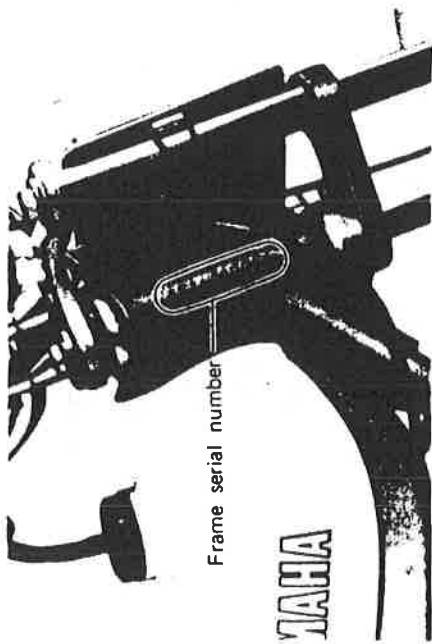

FRAME SERIAL NUMBER

Normally, both serial numbers are identical; however, on occasion they may be two or three numbers off.

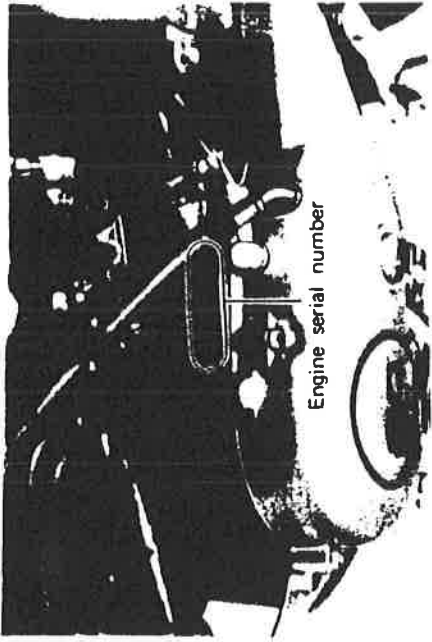

ENGINE SERIAL NUMBER

* -NOTE-

Always check your registration papers against the actual machine serial numbers. If any discrepancy is found, have it corrected immediately.

CHAPTER II SPECIFICATIONS

These specifications are for general use. For a more complete list refer to Maintenance Specifications and/or the GT80A Service Manual.

DIMENSIONS/WEIGHTS	
OVERALL LENGTH	1560 mm (61.4 in.)
OVERALL WIDTH	690 mm (27.2 in.)
OVERALL HEIGHT	890 mm (35.0 in.)
WHEELBASE	1025 mm (40.4 in.)
MINIMUM GROUND CLEARANCE	220 mm (8.7 in.)
SEAT HEIGHT (UNLOADED)	600 mm (23.6 in.)
MACHINE NET WEIGHT	54 kg (119 lbs.)
ENGINE TYPE	2-stroke, Gasoline, "Torque Induction"
BORE/STROKE	47 x 42 mm (1.575 x 1.563 in.)
DISPLACEMENT	72 cc (2.99 cu.in.)

STARTING SYSTEM	Primary Kick
LUBRICATING SYSTEM	Separate Lubrication (Yamaha Autolube)
CARBURETION	<i>TK 45160 - 174LE SPEED SCREW ON SIDE</i>
MANUFACTURER/TYPE/EFFECTIVE VENTURI DIA.	T.K. V16P-3 16 mm-dia
IDLE RPM	1,250 - 1,350 r.p.m.
MAIN JET	#86
NEEDLE JET	2.080
JET NEEDLE#/CLIP POSITION	049-2, 2
AIR JET (TURNS OUT)	1½
FLOAT LEVEL	23.0 mm
CUT AWAY	1.0
AIR CLEANER TYPE	Wet, Molt plain
CLUTCH	
TYPE	Wet, Multiple-disk
PRIMARY DRIVE SYSTEM	Gear
PRIMARY DRIVE RATIO	68/19 (3.578)
TRANSMISSION	
TYPE	Constant Mesh, 4-speed Forward
REDUCTION RATIO	1st 39/12 (3.250)
	2nd 34/17 (2.000)
	3rd 30/21 (1.428)
	4th 27/24 (1.125)

Pilot Jet #34

SECONDARY DRIVE TYPE/SIZE REDUCTION RATIO	DK420/92L 41/12 (3.417)
ELECTRICAL IGNITION TYPE/TIMING SPARK PLUG/MFR/TYPER/GAP	Magneto Ignition, 1.8 mm B.T.D.C. N.G.K. B-6HS
CHASSIS FRAME TYPE FRONT SUSPENSION/TYPER/TRAVEL REAR SUSPENSION/TYPER/TRAVEL STEERING LOCK-TO-LOCK (DEGREES) FRONT CASTER/TRAIL TIRE/SIZE/TREAD TYPE NOMINAL PRESSURE	Double cradle type Telescopic fork 100 mm Swing arm 65 mm 70° 63° 30' 74 mm 2.50-16-4PR Trials Universal 1.4 kg/cm ² (20 lbs/in ²)

REAR TIRE SIZE/TREAD TYPE

3.00-14-4PR Trials Universal

NOMINAL PRESSURE

2.0 kg/cm² (28 lbs/in²)

FRONT BRAKE TYPE/ACTUATING METHOD

Internal Expansion Right hand operation

REAR BRAKE TYPE/ACTUATING METHOD

Internal Expansion Right ahdn operation

VOLUMES/TYPE FLUID

GASOLINE TANK/TYPE

2.5 l

Low-Lead Gasoline

OIL TANK/TYPE

0.22 l

SAE "SE" 10w/30wt

TRANSMISSION/TYPE

500 - 550 cc

SAE "SE" 10w/30wt

FRONT FORK (EACH)/TYPE

85 cc

Non-foaming Hydraulic Fluid

10, 20, 30 wt

NOTE: The Research and Engineering Departments of Yamaha are continually striving to further perfect all models. Improvements and modifications are therefore inevitable.

In light of this fact, all specifications within this manual are subject to change without notice to the owner. Information regarding changes is forwarded to all Authorized Yamaha Dealers as soon as available. If a discrepancy is noted, please consult your dealer.

YAMAHA MOTOR COMPANY LTD.
EXPORT SERVICE DIVISION

CHAPTER III MAINTENANCE SPECIFICATION

PAGE	ITEM	NOMINAL (NEW)	MINIMUM (ALLOWABLE)	MAXIMUM (ALLOWABLE)
30~32	AUTOLUBE Minimum Pump Stroke (At Idle) Maximum Pump Stroke (At Full Throttle)	— —	0.30mm 1.65mm	0.35mm 1.80mm
	MAGNETO/IGNITION			
	Ignition Source Coil Resistance	1.5Ω	—	—
119	Secondary Ignition Coil Resistance (Primary)	1.7Ω	—	—
119	Secondary Ignition Coil Res. (Secondary)	6.0KΩ	—	—
34~36	Ignition Timing	-1.8mm	—	—
34 • 75	Ignition Point Gap	—	0.3mm	0.4mm
120	Condenser Capacity	0.3μF	—	—
	ENGINE—TOP END			
64	Cylinder Taper	0.008mm	—	0.05mm
64	Cylinder Out of Round	—	—	0.005mm
67	Piston Clearance	—	0.035mm	0.040mm
65	Top Ring End Gap (Free)	approximately 7.5mm	—	—
65	Top Ring End Gap (Installed)	—	0.15mm	0.35mm
65	2nd Ring End Gap (Free)	approximately 14mm	—	—
65	2nd Ring End Gap (Installed)	—	0.15mm	0.35mm
66	Ring/Ring Groove Clearance	—	0.03mm	0.08mm
70	Connecting Rod Axial Play	—	0.8mm	2.0mm
70	Connecting Rod/Crank Web Clearance	—	0.4mm	0.5mm
71	Compression Pressure	5.5 kg/cm ² (650 - 700 r.p.m.)	—	—

PAGE	ITEM	NOMINAL (NEW)	MINIMUM (ALLOWABLE)	MAXIMUM (ALLOWABLE)
80 82	ENGINE—CLUTCH Friction Plate Thickness Clutch Plate Warp Allowance	3.5mm	3.2mm	0.05mm
84 84 84	ENGINE—CLUTCH (Continued) Spring Free Length Spring Set Length Difference Primary Driven Gear (Clutch Hsg.) End Play	31.5mm 0.15mm	30.5mm 0.10mm	1mm 0.30mm
100 104 106 106 — —	CHASSIS Front Brake Shoe Diameter Rear Brake Shoe Diameter Wheel Run-out Limits Vertical Wheel Run-out Limits Lateral Front Fork Spring Free Length Rear Shock Spring Free Length	95mm 110mm 302.5mm 214mm	90mm 105mm	2mm 2mm
20 110 — 28 62 75 83 92 92	TORQUE VALUES See, also Torque Chart, Page Transmission Drain Plug Front Fork Cap Bolt Front Axle Securing Nut Rear Axle Securing Nut Cylinder Head Nut Flywheel Securing Nut Clutch Securing Nut Drive Sprocket Securing Nut Driven Sprocket Securing Bolt(s)	3.5 - 4.0 kg-m 3.5 - 4.0 kg-m 3.5 - 4.0 kg-m 4.0 - 4.5 kg-m 1.0 kg-m 3.5 - 4.0 kg-m 4.0 - 4.5 kg-m 4.0 - 4.5 kg-m 2.0 kg-m		

1. Front Brake Lever
2. Rear Brake Pedal
3. Clutch Lever
4. Throttle
5. Kick Crank
6. Kill Button
7. Frame Serial Number
8. Engine Serial Number

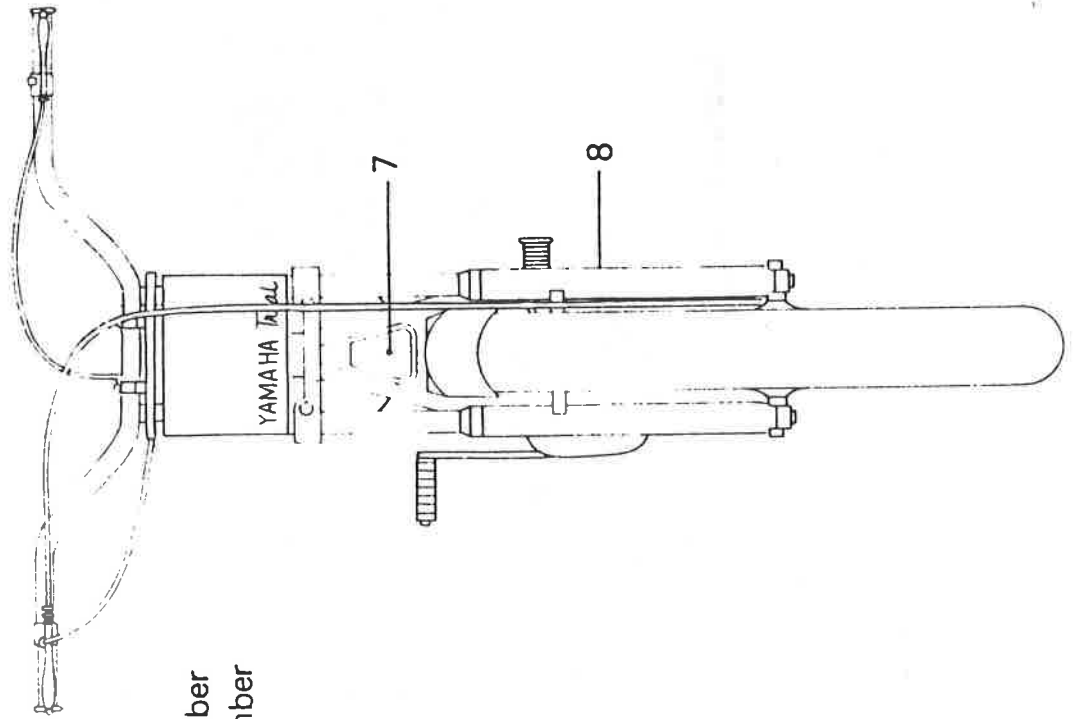
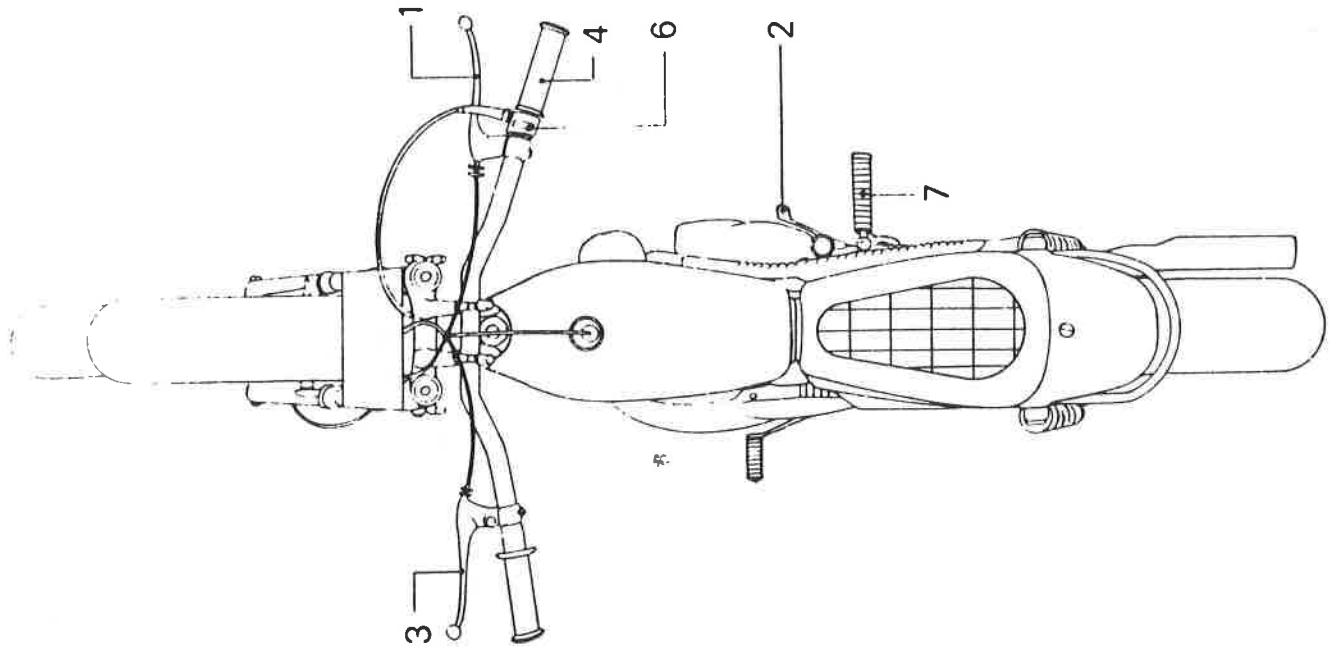

- 9. Fuel Petcock
- 10. Starter Jet
- 11. Shift Lever

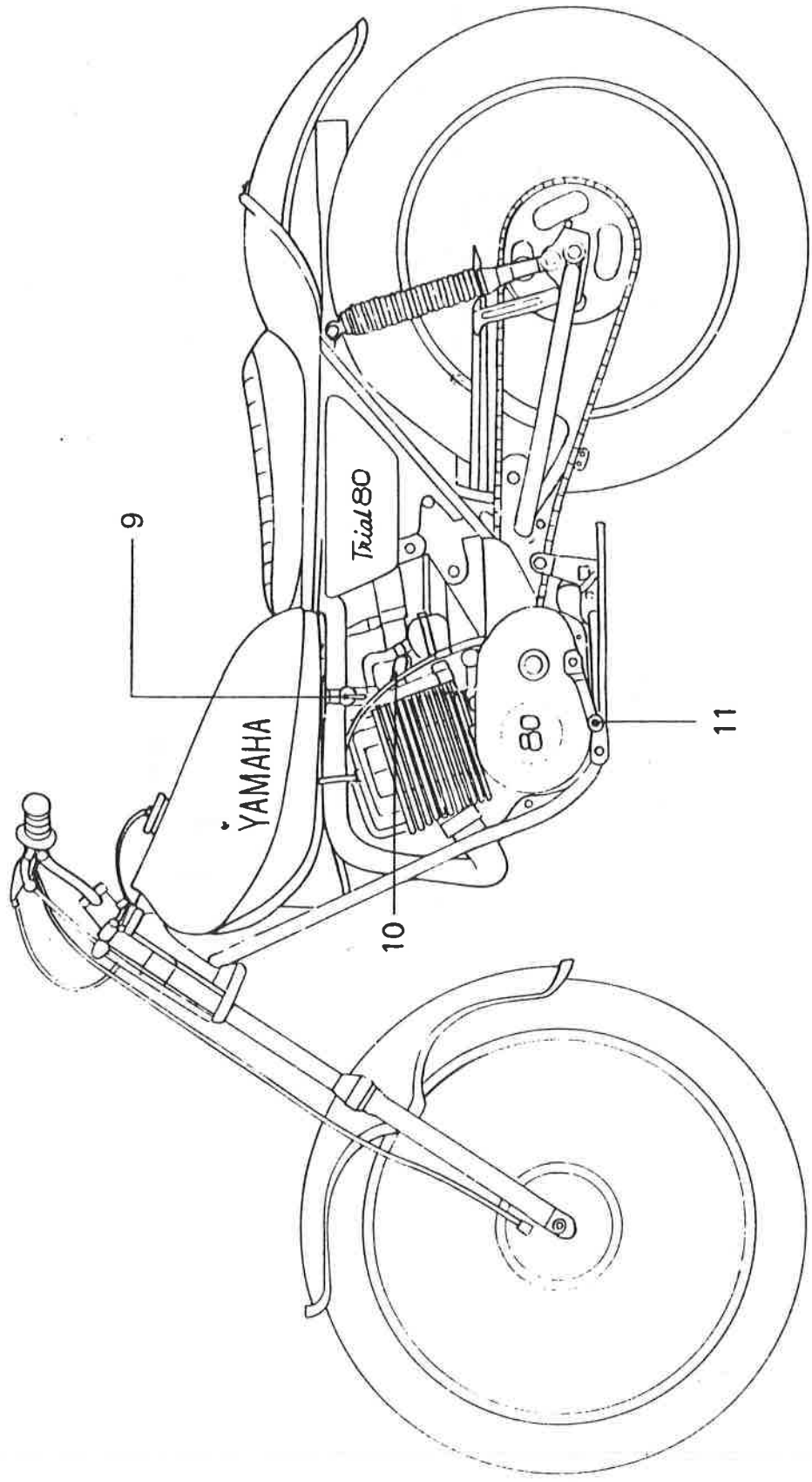

CHAPTER V BASIC INSTRUCTIONS

A. CONTROL FUNCTIONS

1. KILL SWITCH

The Kill switch is the positive type. Push the switch forward for ignition off. Pull the switch toward you on.

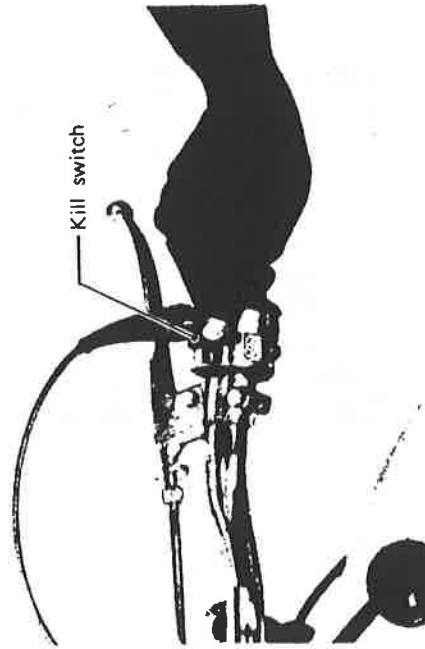

3. FUEL TANK AND PETCOCK

The fuel tank incorporates a threaded plastic filler cap. The cap has a vent tube which is routed to the front of the tank and down alongside a frame down tube.

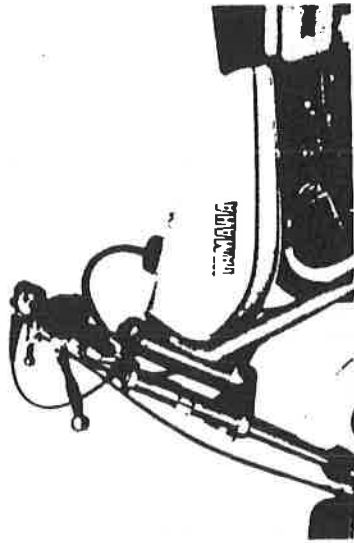

The fuel tank petcock is situated to the left side of the fuel tank. Turn the petcock lever to the vertical position and fuel will flow to the carburetor. Turn lever to the horizontal position to shut off fuel supply to the carburetor.

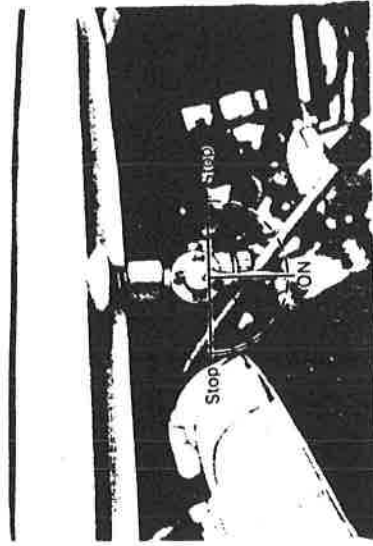

4. FRONT BRAKE LEVER

Located on the right handlebar. The front brake lever actuates the single leading-shoe front brake when brake lever is squeezed.

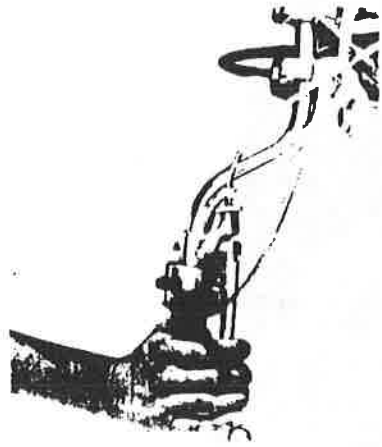

5. REAR BRAKE PEDAL

Located directly in front of the right-hand rider's foot rest. The rear brake pedal actuates the single leading-shoe rear brake when the pedal is depressed.

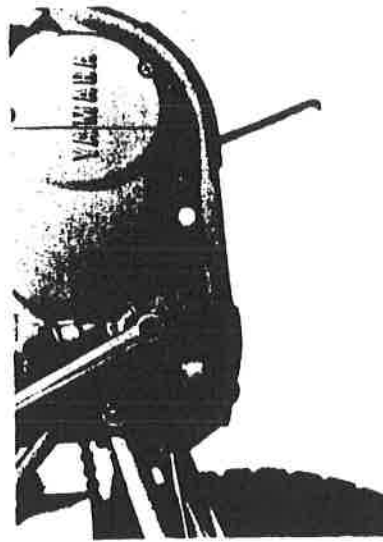



6. CLUTCH LEVER

Located on the left handlebar. The clutch lever will disengage the clutch when the lever is squeezed.

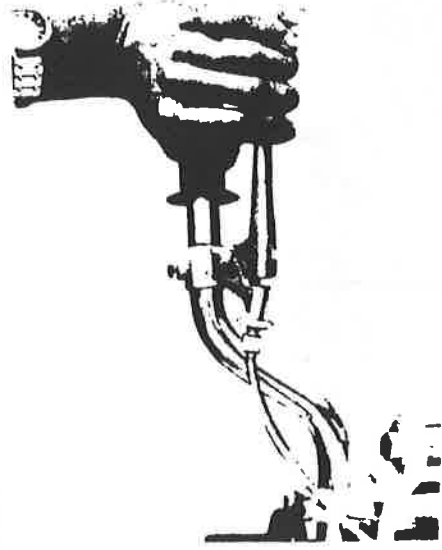

7. THROTTLE

The throttle is the positive-return, type, and is located on the right handlebar.

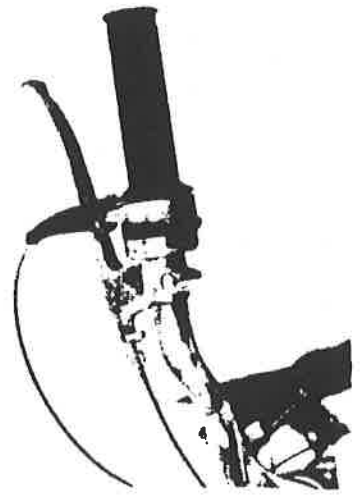

8. KICK CRANK

The kick starter crank is located on the right, rear side of the engine. Set up the right foot rest. Rotate the crank lever out, press your foot upon it firmly, push down until the gears engage the primary drive train and kick briskly to start the engine.

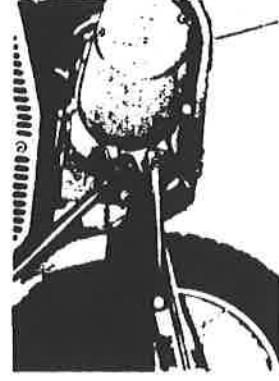

9. SHIFT LEVER

The transmission shift lever is located on the left-hand side of the machine directly in front of the rider's foot rest. The shift mechanism is of the ratcheting type and controls gear selection for the 4-speed transmission.

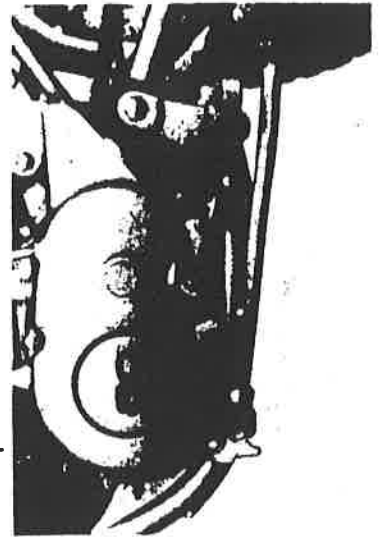

10. CARBURETOR STARTER JET

The carburetor starter jet is located on the left side of the carburetor assembly. The jet is designed to supply an extra rich fuel/air mixture for cold engine starts. It is actuated by a lever. Push the lever down to turn the jet on. Always disengage the lever after the engine is running smoothly. Never ride the machine with the lever down.

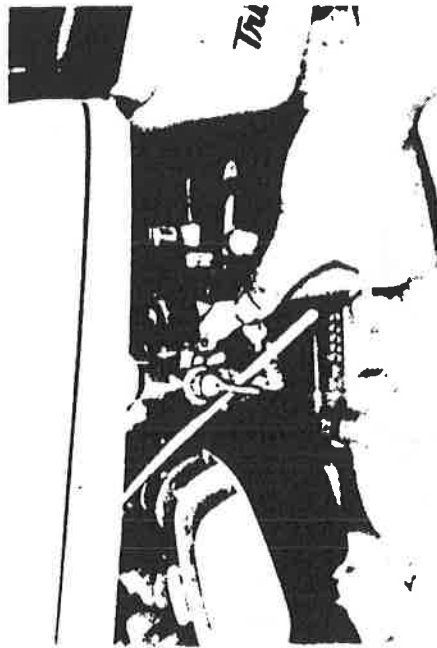

11. DRIVE CHAIN TENSIONER

The drive chain tensioner is located on the underside of the drive chain midway between the drive and driven sprockets.

The tensioner is designed to remove small amounts of excessive chain slack, thereby reducing the "lurch" caused by rapid throttle changes.

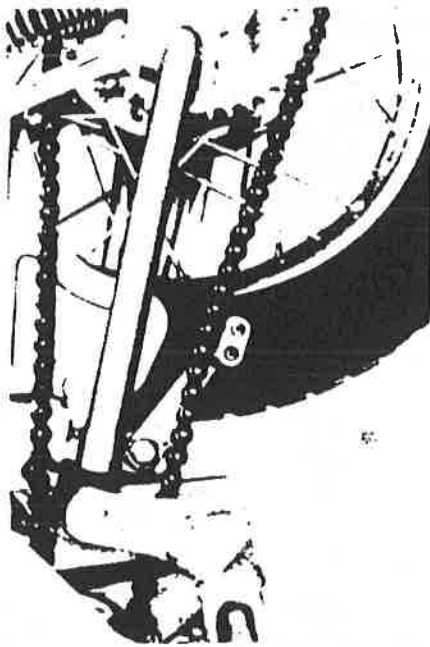

B. GASOLINE AND OIL

1. GASOLINE

Use gasoline with an octane rating of 86+.

Some regular gasolines and most midrange gasolines have such ratings. High-test or Ethyl grade gasolines usually have octane ratings in excess of 94.

Always use fresh, name-brand gasoline.

Low-lead or unleaded gasolines are suitable provided they meet the minimum (86+) octane requirements.

CAUTION:

WITH THE AUTOLUBE FEATURE IT IS UNNECESSARY AND EVEN HARMFUL TO THE ENGINE TO MIX OIL WITH THE GASOLINE. NEVER MIX OIL WITH THE GASOLINE. ALWAYS USE STRAIGHT GASOLINE.

2. OIL

A. Autolube Oil

We recommend that your first choice be Yamalube which can be purchased from any Authorized Yamaha Dealer. If for any reason you should use another type, the oil should meet or exceed BIA certification "TC-W". Check container top or Label for service specification.

CAUTION:

UNDER EXTREMELY COLD CONDITIONS (+32 degrees Fahrenheit or below) SOME OILS BECOME VERY THICK AND WILL NOT FLOW AS READILY TO THE AUTO-LUBE PUMP. THIS MAY CAUSE OIL PUMP STARVATION. YAMALUBE WILL FLOW NORMALLY TO THE PUMP AT AMBIENT TEMPERATURES TO ZERO DEGREES FAHRENHEIT.

3. AUTOLUBE TANK

Always check Autolube tank oil level before operating machine.

A. Remove seat.

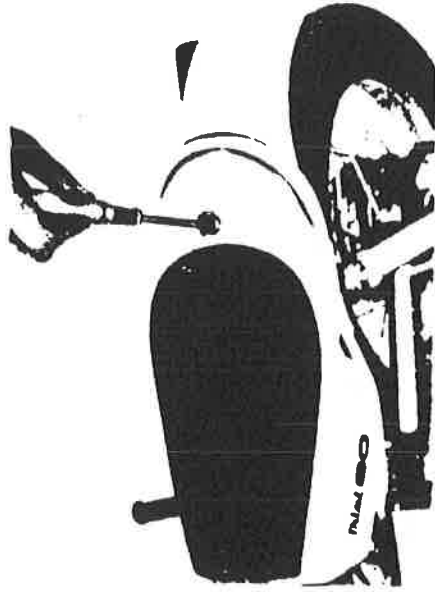

B. Remove cap.



C. Top off tank. Re-install cap and seat.

5. TRANSMISSION

To check level, start the engine and let it run for several minutes to warm and distribute oil. Clean the dipstick. Set it on the case threads in a level position. Remove and check level.

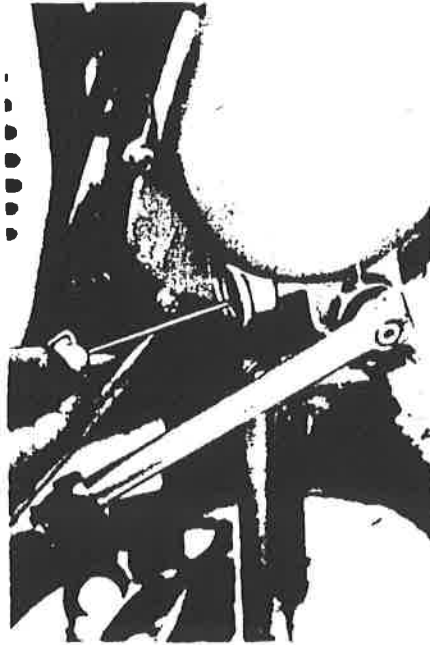

The stick has Minimum and Maximum marks. The oil level should be between the two. Top off as required.

Recommended Oil: Motor Oil, SAE 10W-30wt. Type "SE".

A drain bolt is located on the bottom of the crankcase. With the engine warm, remove the plug and drain oil. Re-install plug and add fresh oil.

Transmission Drain Plug Torque: 3.5 ~ 4.0 kg-m
* (300 ~ 350 In-lbs)

Transmission Oil Quantity: 500 cc (0.53 U.S.qt.)

Transmission oil should be replaced several times during the break-in period. If the unit is used for competition, oil replacement should also be often. See Maintenance Chapter.

NOTE:
BE SURE THE MACHINE IS LEVEL AND ON BOTH WHEELS.

CAUTION

Under no circumstances should any additives be included with the transmission oil. This oil also lubricates and cools the clutch. Many additives will cause severe clutch slippage.

CHAPTER VI OPERATION

CAUTION

1. Before riding this motorcycle, become thoroughly familiar with all operating controls and their function. Consult your Yamaha dealer regarding any control or function you do not thoroughly understand.
2. This model is designed for competition use only. It is not equipped with government approved lighting, mirrors, horn or directional signals. In most instances, it is illegal to ride this model (either day or night) on any public street or highway.

PRE-OPERATION CHECK CHART

ITEM	ROUTINE	PAGE
BRAKES	Check operation/adjustment	26
CLAUTCH	Check operation/lever adjustment	27
AUTOLUBE TANK	Check oil lever/top-off as required	19
TRANSMISSION	Check oil lever/top-off as required	20
DRIVE CHAIN	Check alignment/adjustment/lubrication	28
SPARK PLUG	After bread-in-check color/cond'n weekly/500 mi. [*]	33
THROTTLE	Check for proper cable operation (incl. Autolube cable)	—
AIR FILTER	Foam type - must be clean and damp w/oil always	44 · 45
WHEELS & TIRES	Check pressure/runout/spoke tightness/axle nuts	—
FITTINGS/FASTENERS	Check all - tighten as necessary	—

Pre-operation checks should be made each time the machine is used. Such an inspection can be thoroughly accomplished in a very short time; and the added safety it assures is more than worth the time involved.

CHAPTER VI OPERATION

1. STARTING AND OPERATION

CAUTION:

PRIOR TO OPERATING THE MACHINE, PERFORM STEPS LISTED IN PREOPERATION CHECK LIST.

Turn fuel petcock lever to open (vertical) position. Check ignition kill switch. Kill switch must be on "RUN" position to complete ignition circuit.

A. Starting Cold

Depress the starter lever. Keep the throttle completely closed. Engage the kick starter and start the engine.

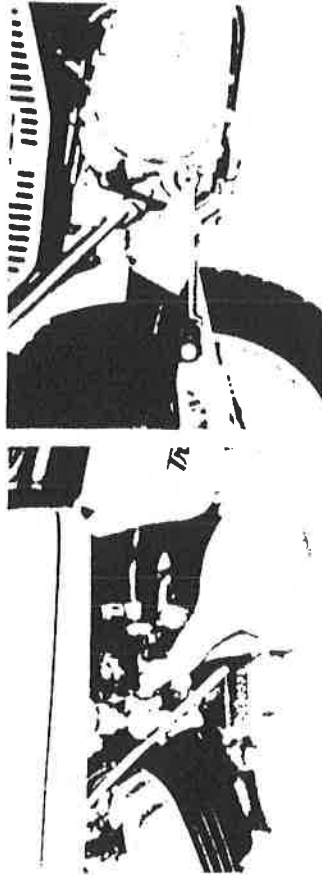

B. Starting with Engine Warm

Do not engage starter lever. Open throttle slightly ($\frac{1}{4}$ turn). Engage the kick starter and start the engine.

C. Warm-up

Run the engine at idle or between idle and $\frac{1}{8}$ th throttle using the starter lever as required until the engine is warm.

This procedure normally takes 2 to 3 minutes. To check, see if the engine responds normally to throttle with starter lever off.

CAUTION:

SEE "BREAK-IN SECTION" PRIOR TO OPERATING ENGINE FOR FIRST TIME.

The kick mechanism is of the primary type.

Therefore, the engine may be started in any gear. Provided clutch is disengaged. The engine may be started in neutral with clutch engaged or disengaged.

A 4-speed transmission is employed. Neutral is at the bottom of the shift pattern; high gear at the top of the shift pattern;

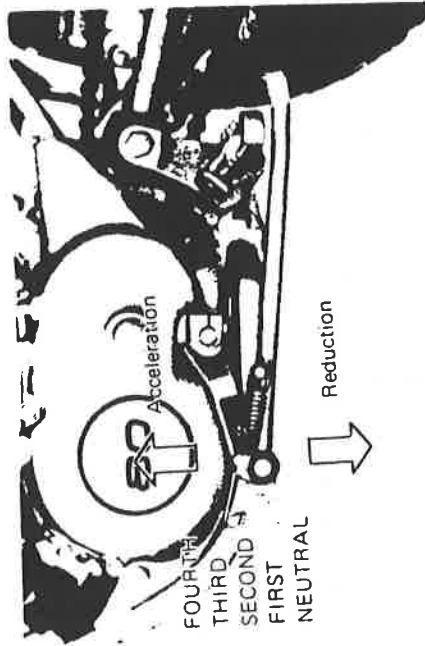

The shift mechanism is of the ratcheting type common to most motorcycles. Allow the lever to return to its "at rest" position prior to selecting another gear. Neutral is selected by shifting "down" to the bottom of the pattern.

With the engine running in the neutral position, disengage the clutch (pull in clutch lever), pull up on the shift lever until first gear is engaged, remove foot from shift lever, increase engine speed slightly, slowly release clutch lever while advancing throttle. Repeat procedure for remaining gears.

Except during competition, shift the transmission when engine speed is approximately 3,000 to 4,000 rpm. This can be interpreted as approximately one-half throttle. (SEE "BREAK-IN")

WARNING

Model TY80A is not equipped with highway-approved lighting. This model is designed solely for competition use and should not be used on streets or highways at any time. In most instances, it is illegal to drive this model on any public streets or highways.

BREAK-IN

You must not put an excessive load on the engine during the first ten to twenty hours of operation. If speedometer mileage is maintained, use the following break-in procedure:

0 to 50 miles (3 Hrs.)

Avoid operation above one half throttle.

50 to 100 miles (3~6 Hrs.)

Avoid full throttle operation. Allow the motorcycle to rev freely through the gears but do not use full throttle at any time.

100 to 250 miles (6~15 Hrs.)

Avoid prolonged full throttle operation.

Avoid cruising speeds in excess of one half throttle. Vary speeds occasionally.

250 miles and beyond (15 + Hrs.)

Avoid full throttle operation. Avoid cruising speeds in excess of 60 mph.

CHAPTER VII MECHANICAL ADJUSTMENTS

1. BRAKES

A. Front Brake

Front brake should be adjusted to suit rider preference with a minimum cable slack of 5-8 mm play at the brake lever pivot point.

Adjustment is accomplished at one of two places; either the handle lever holder or the front brake hub.

- Loosen the adjustor locknut.
- Turn the cable length adjustor in or out until adjustment is suitable.
- Tighten the adjusting bolt locknut.



B. Rear Brake

Adjust rear brake pedal play to suit, providing a minimum of 25mm freeplay. Adjustment is accomplished as follows:

- Using a 13mm wrench, turn the adjusting nut on the rear brake ferrule in or out until brake pedal freeplay is suitable (25mm minimum freeplay).

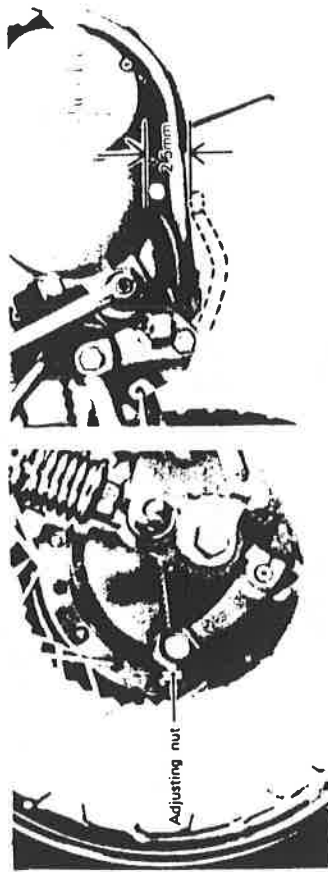

NOTE: Rear brake pedal adjustment must be checked whenever chain is adjusted or rear wheel is removed and then reinstalled.

2. CLUTCH ADJUSTMENT

Proper clutch adjustment requires two separate procedures.

- A. Loosen cable, adjust screw locknut.
- B. Turn clutch cable adjustor (at lever) all the way into the lever.

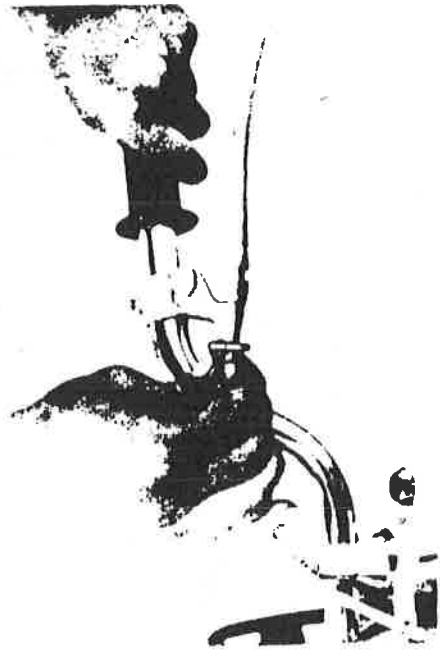

NOTE: The above procedure provides for maximum cable freeplay to allow for proper clutch actuating mechanism adjustment.

- C. Remove cover cap on left crankcase cover.
- D. Loosen adjustor locknut.
- E. Using a Phillips screwdriver, turn adjust screw in or out until clutch arm (located under the engine directly below the adjust screw), is directly in line with the main axle center line.

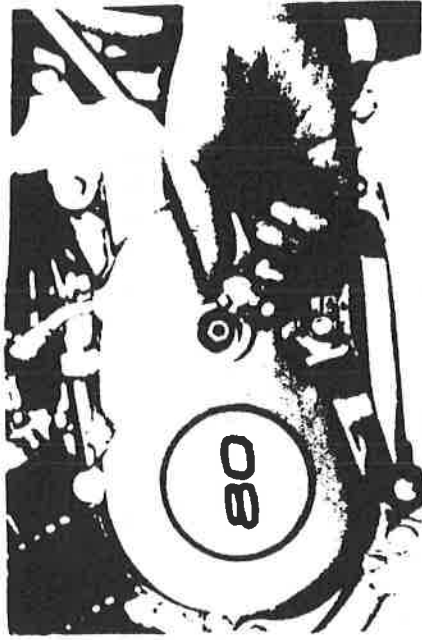

- F. Tighten locknut.
- G. At clutch lever assembly, left handlebar, turn cable length adjustor in or out until freeplay at lever pivot equals 2~3mm.
- H. Tighten adjusting bolt locknut.
- I. Re-install cover cap.

3. DRIVE CHAIN ADJUSTMENT

To adjust drive chain, proceed as follows:

- A. Remove rear axle cotter pin.
- B. Loosen rear axle securing nut.



- C. With rider in position on machine, both wheels on ground, set axle adjusters until there is $\frac{3}{4}$ to 1 inch slack in the drive chain at the bottom of the chain at a point midway between the drive and driven axles.

- D. Turn cam adjusters both left and right until axle is situated in same cam slot position.

- E. Tighten the rear axle securing nut. Rear axle tightening torque equals

Axle Nut Torque: 4.0~4.5 kg-m
(350~400 In-lbs)

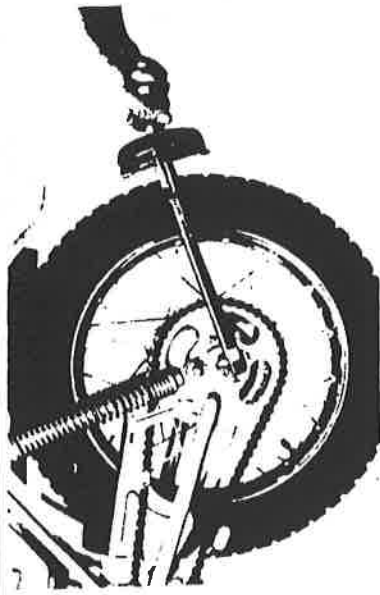

- F. Install a new cotter pin, bend the ends.

G. Check brake pedal free play.

CAUTION:

Whenever the chain is adjusted and/or the rear wheel is removed, always check during reassembly:

1. Rear axle alignment
2. Brake pedal freeplay

4. CARBURETOR

Under normal operating conditions, there are only three adjustments to be made to the carburetor.

A. Throttle cable adjustment:

- 1) Lift the rubber mixing chamber cap cover from the top of the carburetor.
- 2) Grasp outer cable housing. Lift up.
Slack should equal 1mm. If slack is incorrect, loosen adjusting bolt locknut and turn adjusting bolt in or out as required to achieve correct slack. Tighten adjusting bolt locknut. Reinstall cap cover.

3) Grasp throttle cable housing at throttle assembly at right handlebar. Pull out. Slack should equal 1mm. If not, loosen cable length adjuster locknut and adjust cable length accordingly.

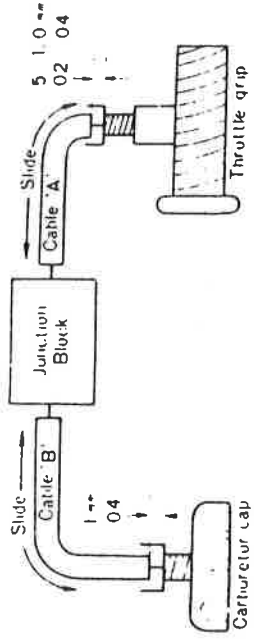

4) Tighten adjuster locknut.

B. Idle speed and idle air adjustments:

- 1) Turn idle air screw in until lightly seated.
- 2) Back out 1½ turns.



- 3) Turn idle speed adjust screw until idle is approximately 1250 to 1350 rpm.

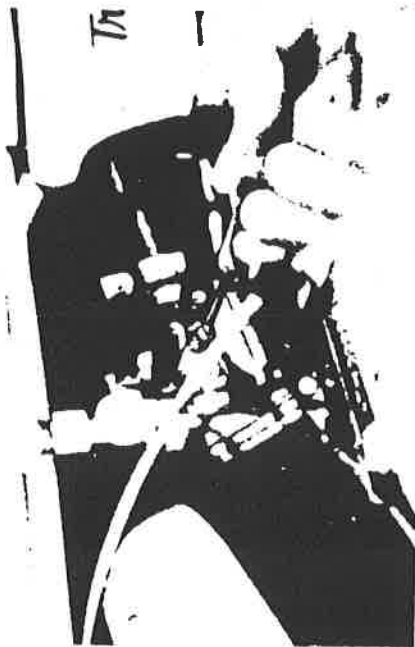

Idle Air Screw: 1 1/2 turns out
Idle Speed: 1250~1350 rpm

NOTE:

Idle air mixture and idle speed adjustment screws should be so adjusted that engine response to throttle changes from idle position is rapid and without hesitation.

If the engine, when warm, hesitates or "bogs", after adjusting as described, turn idle air mixture screw in or out in 1/4 turn increments until bogging problem decreases.

Readjust idle speed, recheck throttle cable slack.

5. ADJUSTING AUTOLUBE

Cable Adjustment

1. Remove Autolube pump cover, which is located on forward portion of crankcase cover (R).



2. Rotate throttle until all slack is removed from all cables. Hold this position.

Pump Stroke Adjustment

NOTE:

Autolube pump stroke adjustment requires special tool. This tool, Autolube Pump Feeler Gauge, may be purchased from your Authorized Yamaha Dealer.

1. Rotate plastic bleed wheel until the pump plunger moves fully out and away from the pump body to its outermost limit.



3. Check to see that Autolube pump plunger pin is aligned with the mark on the Autolube pump pulley.



4. If the mark and pin are not in alignment, loosen cable length adjuster lock nut on upper edge of crankcase cover and adjust cable length until alignment is achieved. Tighten adjuster locknut.

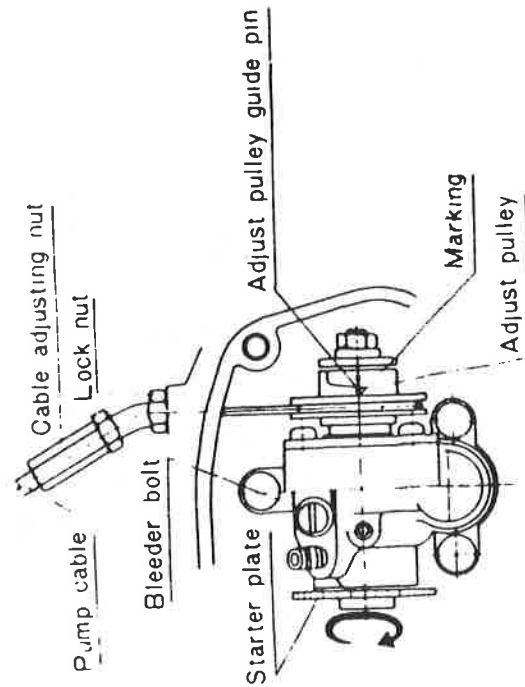

2. Measure gap between raised boss on pump cable pulley and pump stopper plate. Clearance should equal 0.30 to 0.25mm. If clearance is incorrect, remove adjust plate locknut and adjust plate.

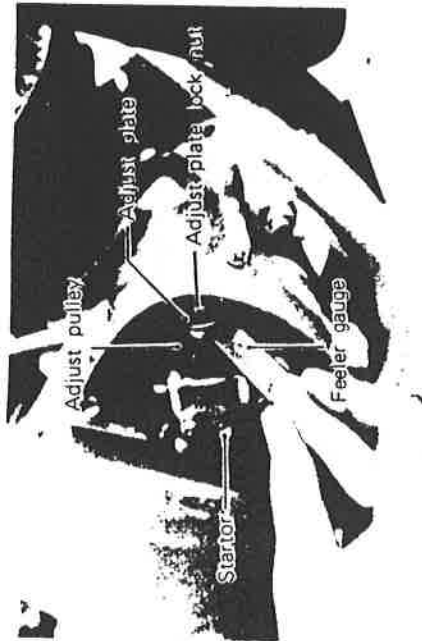

Minimum Pump Stroke: 0.30~0.35mm
(0.012~0.014 in)

3. Remove or add an adjustment shim as required.



4. Reinstall adjust plate and locknut. Tighten the locknut. Re-measure gap. Repeat procedure as required.



6. SPARK PLUG

The spark plug in your machine indicates how the engine is operating. If the engine is operating correctly, and the machine is being ridden correctly, then the tip of the white insulator around the positive electrode of the spark plug will be a medium to light tan color. If the porcelain "donut" around the positive electrode is a very dark brown or black color, than a plug with a hotter heat range might be required. This situation is quite common during the engine break-in period.

If the insulator tip shows a very light tan or white color or is actually pure white or if electrodes show signs of melting, then a spark plug with a colder heat range is required.

Remember, the insulator area surrounding the positive electrode of the spark plug must be a medium-to-light tan color. If it is not, check carburetion, timing and ignition adjustments. If the situation persists, consult your Authorized Yamaha Dealer.

Your machine is equipped with a relatively hot spark plug to insure clean, smooth low speed operation. If the machine is to be operated at higher R.P.M. ranges for extended periods, install the next colder spark plug.

The spark plug must be removed and checked prior to using the machine. Check electrode wear, insulator color, and negative to positive electrode gap.

Spark Plug Gap: 0.5 ~0.6mm (0.20~0.24 in)

It is alright for you, as the owner, to exchange the standard plug. Engine conditions will cause any spark plug to slowly break down and erode. If erosion begins to increase, or if the electrodes finally become too worn, or if for any reason you believe the spark plug is not functioning correctly, replace it.

Standard Spark Plug: B-6HS

When installing the plug, always clean the gasket surface, use a new gasket, wipe off any grime that might be present on the surface of the spark plug, torque the spark plug properly.

Spark Plug Tightening Torque: 2.7~2.9 kg-m
(230 ~250 In-lbs)

7. IGNITION TIMING

Ignition timing must be set with a dial indicator (to determine piston position) and a low-range ohmmeter (to determine exactly when contact breaker points begin to open). Proceed as follows:

- A. Remove spark plug and screw Dial Gauge Stand into spark plug hole.
- B. Insert Dial Gauge Assembly into spark plug stand.

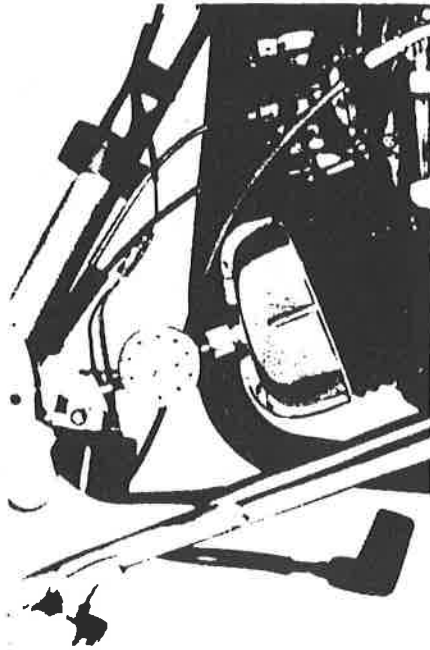

- C. Remove left crankcase cover to gain access to contact breaker assembly (ignition points).
- D. Connect red lead of Point Checker to black wire in wire harness coming from magneto.
- E. Connect black lead of Point Checker to unpainted surface of cylinder fin or crankcase bolt or screw.

F. Rotate magneto flywheel until piston is at top-dead-center (T.D.C.). Tighten set screw on dial gauge stand to secure dial gauge assembly. Set the zero on dial indicator face to line up exactly with dial indicator needle. Rotate flywheel back and forth to be sure that indicator needle does not go past zero.

G. Starting at T.D.C. rotate flywheel clockwise until dial indicator reads approximately 1.8mm (0.07") before top-dead-center (B.T.D.C.).

H. Slowly turn flywheel counter-clockwise until gauge indicates correct timing figure. At this time, the ohmmeter needle should swing from "CLOSED" to "OPEN" position, indicating the contact breaker (ignition points) have just begun to open.

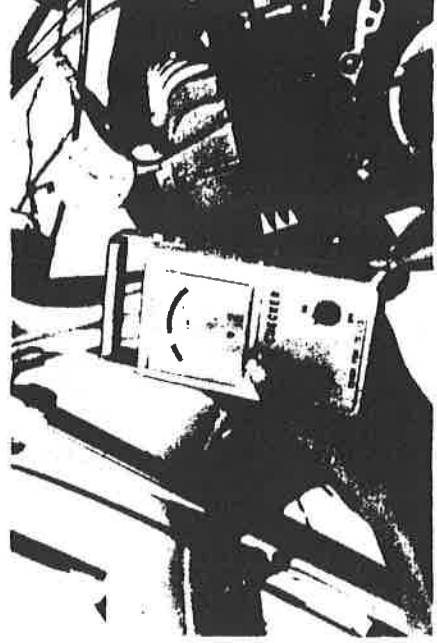

Ignition Timing: 1.8mm B.T.D.C.

K. When correct ignition timing has been accomplished, check maximum point gap by turning flywheel until maximum point opening occurs. Measure point gap with thickness gauge.

Maximum Allowable Point Gap: 0.3 ~0.4mm
(0.012 ~0.016 in.)

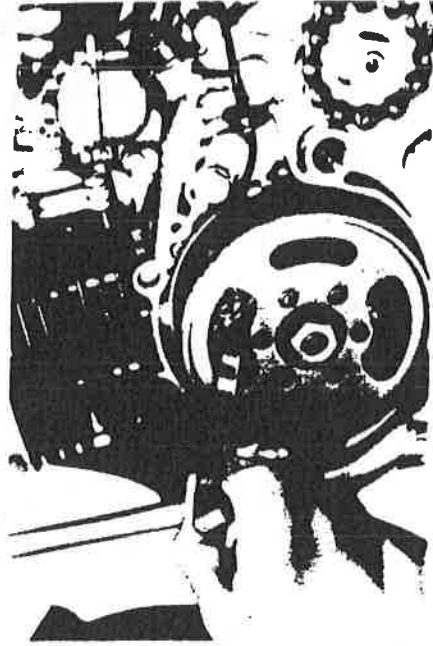

- I. Repeat step H to verify point opening position. If points do not open within specified tolerance, they must be adjusted.
- J. Adjust ignition points by barely loosening Phillips-head screw and carefully rotating contact breaker assembly with a slotted screwdriver until point checker indicates points "OPEN". Re-tighten Phillips-head screw. Repeat steps F thru H.



NOTE:

If the maximum point gap is over tolerance the point rubbing block is probably worn and the contact breaker assembly should be replaced. Do not attempt to bend the fixed point bracket to decrease maximum point gap. This will only result in point misalignment, difficulty in setting timing and premature point failure. See "Magneto Flywheel Removal" for point replacement procedure.

L. Remove dial gauge assembly and dial gauge stand.
Replace spark plug.

Spark Plug Torque: 2.7~2.9 kg-m
(230~250 in-lbs.)



M. Disconnect point checker.
N. Replace crankcase cover (L).

CHAPTER VIII MAINTENANCE AND MINOR REPAIRS

The following sections provide information for the disassembly, troubleshooting and maintenance of various components of the motorcycle. If you do not have the necessary tools and an understanding of the mechanical principles involved, please refrain from attempting repairs. The use of improper tools and/or procedures can cause major damage to the unit with resultant additional repair costs.

To properly understand the procedures outlined we suggest you consult the GT80A Service Manual (1974) and the various other technical publications produced by Yamaha Motor Company or Yamaha International Corporation.

Finally, we suggest you consult your Yamaha Dealer prior to attempting any repair procedures. This is particularly important during the first ninety days the machine is in use.

PERIODIC MAINTENANCE INTERVALS

Page	Item	Remarks	Initial (miles)			Thereafter every (miles)
			250	500	1,000	
26	Brake System (Complete)	Check/Adjust as required-Repair as required	<input type="checkbox"/>	<input type="checkbox"/>	<input type="checkbox"/>	500
27	Clutch	Check/Adjust as required	<input type="checkbox"/>	<input type="checkbox"/>	<input type="checkbox"/>	500
33	Spark Plug	Inspect/Clean or replace as required	<input type="checkbox"/>	<input type="checkbox"/>	<input type="checkbox"/>	500
—	Wheels and Tires	Pressure/Spoke Tension/Rounout	<input type="checkbox"/>	<input type="checkbox"/>	<input type="checkbox"/>	500
—	Fittings and Fasteners	Tighten before each trip and/or	<input type="checkbox"/>	<input type="checkbox"/>	<input type="checkbox"/>	500
—	Throttle	Cable Oper./Adj. (incl. Autolube)	<input type="checkbox"/>	<input type="checkbox"/>	<input type="checkbox"/>	500
28	Drive Chain	Tension/Alignment	<input type="checkbox"/>	<input type="checkbox"/>	<input type="checkbox"/>	500
20	Transmission Oil Level	Includes Trans./Autolube tank (See Note 1)	<input type="checkbox"/>	<input type="checkbox"/>	<input type="checkbox"/>	500
44 45	Air Filter	Foam Type (See Service Notes 2 & 4)	<input type="checkbox"/>	<input type="checkbox"/>	<input type="checkbox"/>	500
—	Fuel Petcock	Clean/Flush tank as required	<input type="checkbox"/>	<input type="checkbox"/>	<input type="checkbox"/>	500
34 35 36	Ignition timing	Adjust/Clean/Replace points as required	<input type="checkbox"/>	<input type="checkbox"/>	<input type="checkbox"/>	500
29 30	Carburetor Adjustment	Check Operation/Synch./Fittings	<input type="checkbox"/>	<input type="checkbox"/>	<input type="checkbox"/>	500
46 ~ 54	Carburetor Overhaul	Clean/Repair as required/Refit/Adjust	<input type="checkbox"/>	<input type="checkbox"/>	<input type="checkbox"/>	500
—	Cylinder Compression	Preventive Maintenance check	<input type="checkbox"/>	<input type="checkbox"/>	<input type="checkbox"/>	500
—	Decarbonize Engine	Includes Exhaust System	<input type="checkbox"/>	<input type="checkbox"/>	<input type="checkbox"/>	500

SERVICE NOTES:

1. Check Autolube tank level before each ride. Top off when oil level shows at the sight glass or before any prolonged use. See "Lubrication Intervals" for type oil to use.
2. Foam element air filters must be damp with oil at all times to function properly. Remove, clean, and oil filter at least once per month or every 250~500 miles; whichever occurs first. (If extremely hard usage, such as dirt riding, clean and lube daily.) See "Lubrication Intervals" for additional details.
3. Pre-operational checks should be made each time the machine is used. Such an inspection can be thoroughly accomplished in a very short time, and the added safety it assures the rider is more than worth the minimal time involved.
4. For additional information regarding drive chain, engine oil level, wet-type air filter, see "Lubrication Intervals".

LUBRICATION INTERVALS

Item	Remarks	Period			
		Initial (miles)		Thereafter Every (miles)	
		250	500	1,000	500 1,000
Autolube	P See Service Notes	No. 1			
Transmission oil	E Warm engine before draining	No. 2	○ CHK	○	○
Drive Chain	O Lube/Adjust as required	No. 3			
Drive Chain	P Remove/Clean/Lube/Adjust	No. 3	○	○	○
Air Filter	H Foam type	No. 9			
Control & Meter Cables	K All-Apply Thoroughly	No. 4	○		○
Throttle Grip & Housing	L Light Application	No. 5	○		○
Rear Arm Pivot Shaft	M Zirc-Apply until shows	No. 6		○	○
Brake Pedal Shaft	N Light Application	No. 5		○	○
Change Pedal Shaft	O Light Application	No. 5		○	○
Front Forks	P Drain Completely-Ck Specs	No. 3	CHK	○	○
Steering Ball Races	Q Inspect Thoroughly/Med. Pack	No. 7		○	○
Point Cam Lubr. Wick	R Very Light Application	No. 8		○	○
Wheel Bearings	S Do not Over-Pack	No. 7		○	○

No. 1 Check tank level before each ride. Top off when oil level is at sight glass or before any prolonged use. Use the following lubricant (in order of preference):

Yamalube, or; two-stroke oil labeled "BIA certified for service TC-W"
 No. 2 At ambient temperatures of 45-90° F. use 10W/30 "SE". Do not use "additives" in oil.
 No. 3 Use 10W/30 "SE" motor oil. (If desired, specialty type lubricants of quality manufacture may be used.)

"Drive Chains" - Lube every 150-200 miles. If severe usage, every 50-100 miles or after every event.

No. 4 Use graphic base type (specialty types available use name-brand, quality manufacturer).

No. 5 Light duty: smooth, light-weight, "white" grease. Heavy duty: standard 90wt. lube grease (do not use lube grease on throttle/housing).

No. 6 Use standard 90wt. lube grease - smooth, not coarse.

No. 7 Medium-weight wheel bearing grease of quality manufacturer - preferably waterproof.

No. 8 Light-weight machine oil.

No. 9 Air filters - foam element air filters must be damp with oil at all times to function properly. Clean and lube monthly or per mileage. If hard usage, clean and lube daily. Do not over-oil. Use SAE 10W/30 "SE".

MAINTENANCE AND LUBRICATION INTERVALS

These charts should be considered strictly as a guide to general maintenance and lubrication intervals. You must take into consideration that weather, terrain, geographical locations, and a variety of individual uses all tend to demand that each owner alter this time schedule to match his environment. For example, if the motorcycle is continually operated in an area of high humidity, then all parts must be lubricated much more frequently than shown on the chart to avoid the damage caused by water to metal parts. If you are in doubt as to how closely you can follow these time recommendations, check with the YAMAHA dealer in your area.

COMPETITION

The serious competitor will no doubt already have a maintenance and lubrication schedule of his own. However, until one can be established according to individual usage, we suggest the following:

1. Cut the mileage recommendations by one-half. If no speedometer; estimate 10-15 mph average speed.

2. Immediately preceding each competition, pay particular attention to the following:

1. A thorough Pre-operation check.
 2. Clean and lubricate air filter.
 3. Lubricate all controls, cables and rear arm pivot.
3. Every other competition, perform the steps outlined in No. 2, and:
1. Disassemble top end and inspect.
 2. Replace piston rings.
 3. Decarbonize as required.
 4. Service carburetor.
 5. Replace transmission oil.
 6. Check front fork operation and steering adjustment.
 7. Remove chain; clean, oil and re-install.
 8. Remove wheel assemblies and service brakes.
 9. Check rear shock and swing arm operation.
 10. Adjust Autolube pump stroke and cable.

TORQUE SPECIFICATIONS

The list below covers those stud/bolt sizes with standard I.S.O. pitch threads. Torque specifications for components with thread pitches other than standard are given within the applicable chapter.

Torque specifications call for dry, clean threads. Components such as the cylinder or cylinder head should be at room temperature prior to torquing. A cylinder head or any other item with several fasteners should be torqued down in a cross-hatch pattern in successive stages until torque specification is reached. The method is similar to installing an automobile wheel and will avoid warping the component.

A (NUT)	B (BOLT)	TORQUE SPECIFICATION		
		Kg-m	Ft-lbs	In-lbs
10mm	6mm	1.0	7.2	85
13mm	8mm	2.0	15	175
14mm	8mm	2.0	15	175
17mm	10mm	3.5 - 4.0	25 - 29	300 - 350
19mm	12mm	4.0 - 4.5	29 - 33	350 - 400
22mm	14mm	4.5 - 5.0	33 - 36	400 - 440
26mm	17mm	5.8 - 7.0	42 - 50	500 - 600
27mm	18mm	5.8 - 7.0	42 - 50	500 - 600
30mm	20mm	7.0 - 8.3	50 - 60	600 - 700
SPARK PLUG		2.7 - 2.9	19 - 21	230 - 250



TOOLS

The Owner's Tool Kit supplied with the machine provides the minimum tools required for emergency repairs and minor maintenance. The maintenance procedures outlined within this manual require additional special tools and instruments. A comprehensive list of the special tools is given below. For your convenience, we have also included a list of additional recommended hand tools and supplies.

SPECIAL TOOLS AND INSTRUMENTS

- *1. Autolube Feeler Gauge
- *2. Vernier Calipers (0-150mm)
- *3. Clutch Holding Tool
- *4. Magneto Flywheel Puller (YGI)
- *5. Dial Gauge (mm)
- *6. Dial Gauge Stand
- *7. Point Checker (or continuity checker)
- *8. Outside Micrometer (50-75mm)
- *9. Cylinder Gauge (50-100mm)
10. Torque Wrench (0-10 Kg-m or 0-600 in-lb)
11. Feeler Gauge Set

NOTE: Those items marked with an asterick () available from your Yamaha dealer.

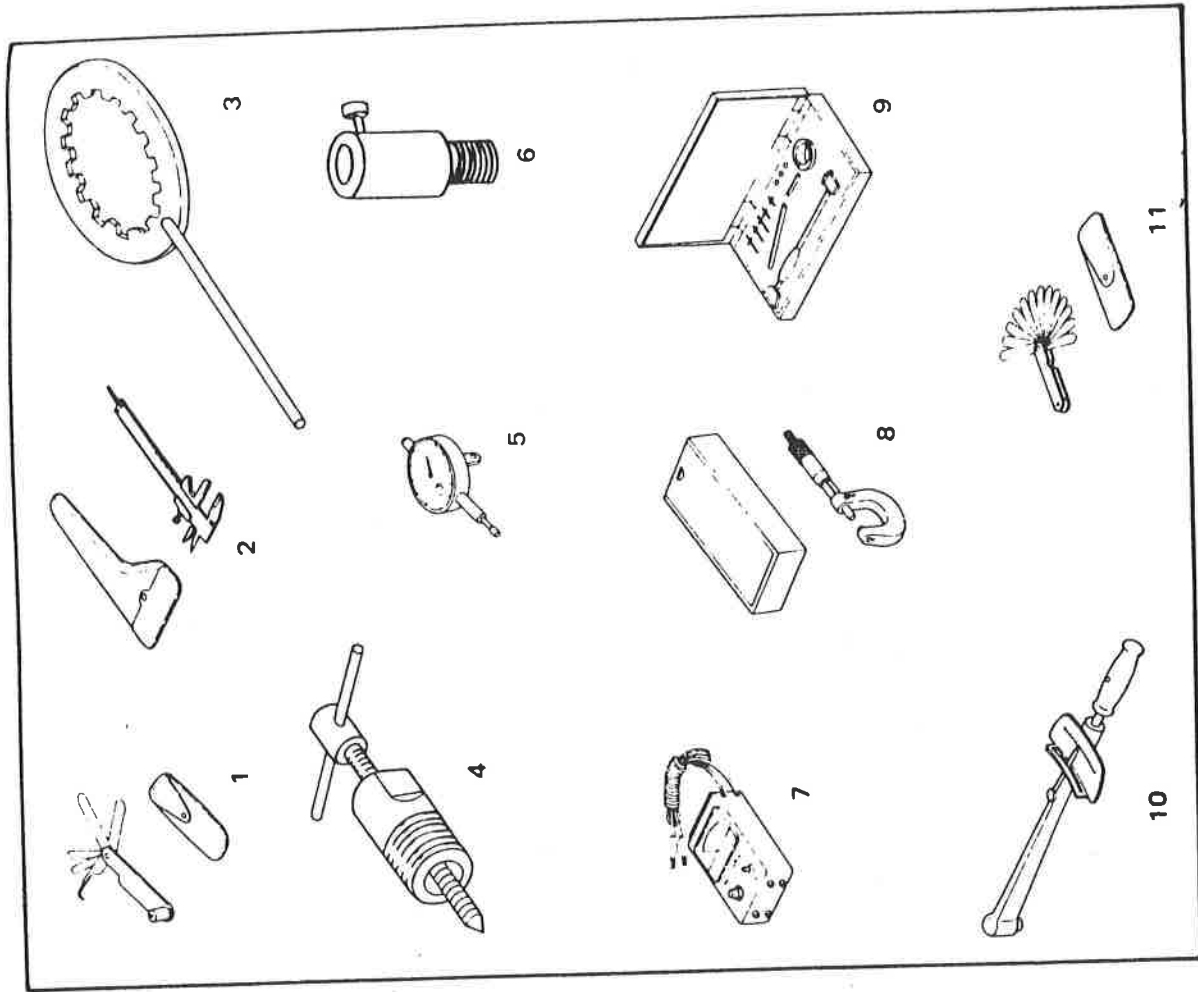

GENERAL TOOLS AND MATERIALS

1. TY80A Gasket Kit
- *2. Socket Wrench Set (mm)
- *3. Combination Wrench Set (mm)
4. Selection of Phillips and Standard Screwdrivers
5. Circlip Pliers (outside)
6. Soft faced Hammer
7. Steel Hammer
8. Selection of pliers and wire cutters
9. Several Parts Trays and Shop Rags

*NOTE: See torque chart for sizes required.

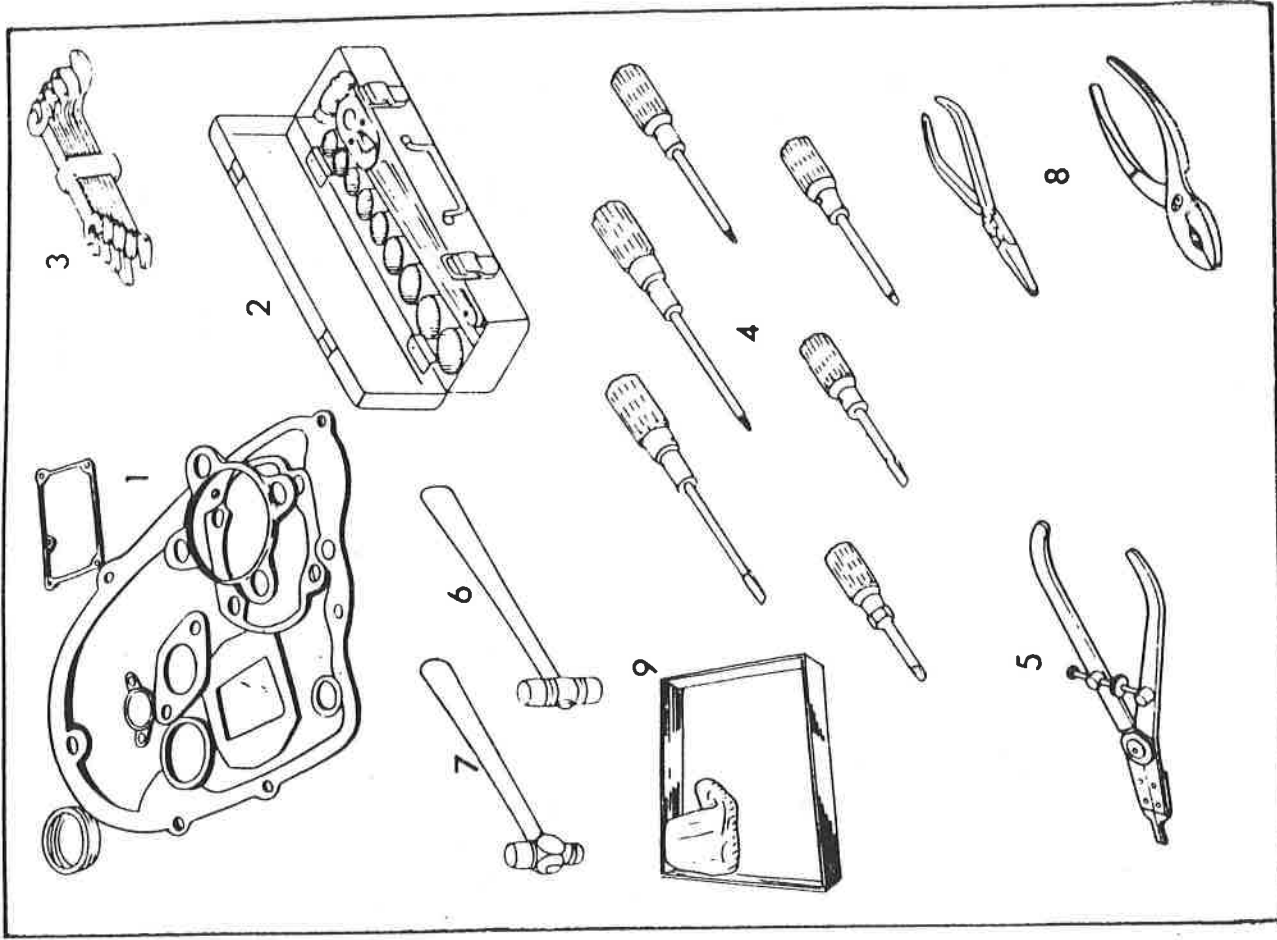

AIR FILTER

1. Remove the lefthand side cover.



2. Remove the Phillips-head screw holding the air filter case cover in place. Remove the cover.

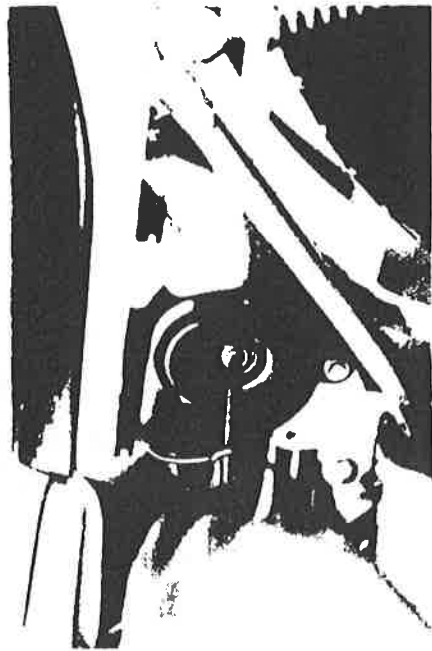

3. Remove the air filter element.



4. Slip the element off the wire mesh guide.

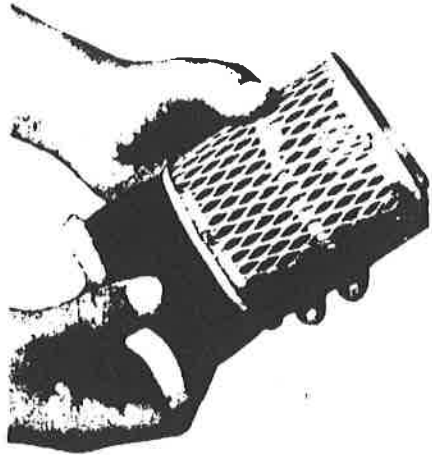

5. Wash the element gently, but thoroughly, in solvent.
6. Squeeze excess solvent out of element and dry.

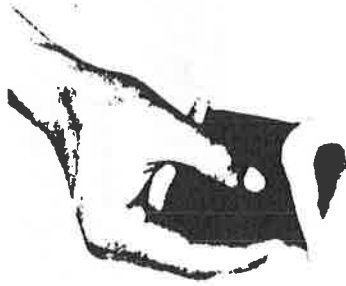

8. Re-insert the wire mesh filter element guide into the element.
9. Coat the ends of the filter element with 90wt. lube grease. This will provide an air-tight seal between the filter case cover and filter seat.
10. Re-install the element, case cover and seat.

NOTE: Each time filter element maintenance is performed, check the air inlet to the filter case for obstructions. Check the air cleaner joint rubber to the carburetor and manifold fittings for an air-tight seal. Tighten all fittings thoroughly to avoid the possibility of unfiltered air entering the engine.

7. Pour a small quantity of motor oil onto filter element and work thoroughly into the porous foam material.

NOTE: In order to function properly, the element must be damp with oil at all times..... but not "dripping" with oil.

CAUTION

Never operate the engine with the air filter element removed. This will allow unfiltered air to enter causing rapid wear and possible engine damage. Additionally, operation without the filter element will affect carburetor jetting with subsequent poor performance and possible engine over-heating.

CARBURETOR

1. Turn fuel petcock lever to the "STOP" position.
2. Remove the gasoline tank fuel line from fitting at carburetor.



3. Loosen the carburetor body fitting screw and inlet joint band (hose clamp).

NOTE: For carburetor main jet replacement only, follow steps 1 through 3; then:

1. Remove carburetor.
2. Remove four (4) screws that secure float chamber body.
Remove float chamber body.

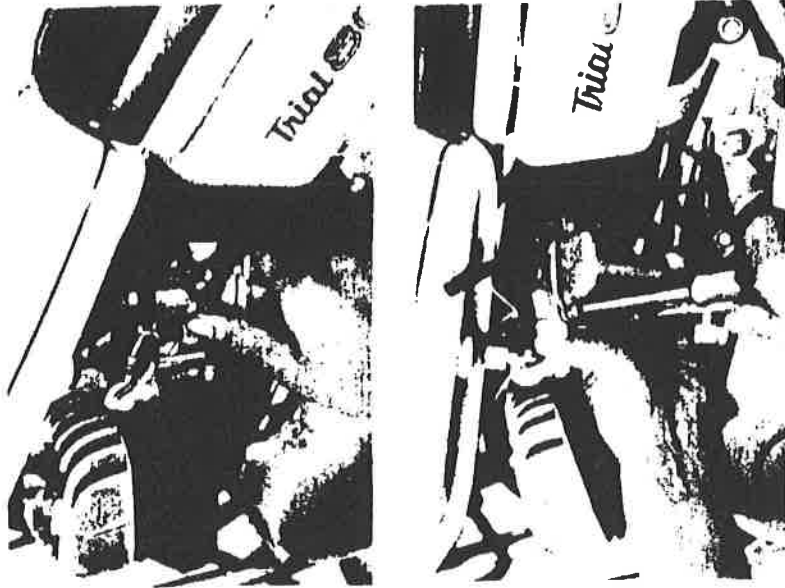

CAUTION

Removing the float chamber body will allow fuel to drain. Do not remove if engine is hot. Place a rag under carburetor to catch overflow. Remove float chamber body in well-ventilated area. Do not remove near open flame. Always clean and dry machine after re-assembly.

3. Main jet screws into main nozzle body. Remove main jet. Change as required. Re-install float chamber body and reassemble, reversing steps 1 through 3.

Main Jet: # 86

4. Push the air cleaner joint (hose) off the carburetor inlet.



CARBURETOR

SOME HAVE 10-12 SPEED
ADD SCREW ON TOP,
NEXT TO CABLE-

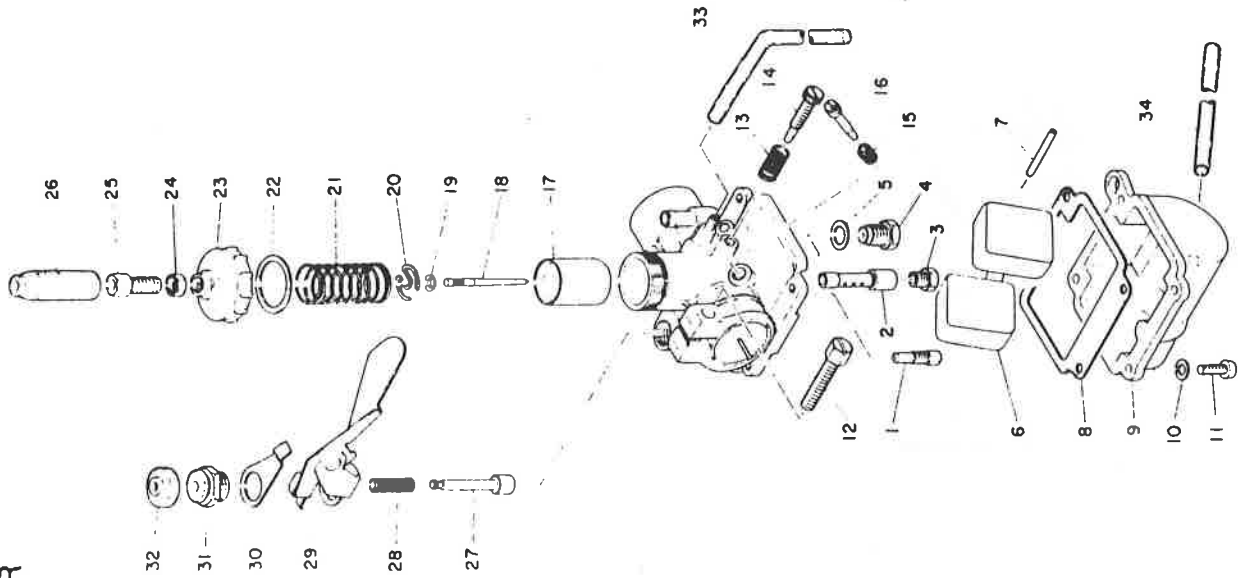

- | | |
|----------------------------|---------------------------|
| 1. Pilot jet | 18. Needle |
| 2. Main nozzle | 19. Clip |
| 3. Main jet | 20. spring seat |
| 4. Valve seat ass'y | 21. Throttle valve spring |
| 5. Valve seat washer | 22. Packing |
| 6. Float | 23. Mixing chamber cap |
| 7. Float pin | 24. Wire adjusting nut |
| 8. Gasket | 25. Wire adjusting screw |
| 9. Float chamber body | 26. Cap |
| 10. Spring washer | 27. Starter plunger |
| 11. Panhead screw | 28. Plunger spring |
| 12. Body fitting screw | 29. Starter lever |
| 13. Pilot adjusting spring | 30. Stopper |
| 14. Pilot adjusting screw | 31. Plunger cap |
| 15. Air adjusting spring | 32. Plunger cap cover |
| 16. Air adjusting screw | 33. Pipe |
| 17. Throttle valve | 34. Over flow pipe |

5. Rotating the carburetor body, work it off the cylinder manifold joint.



7. Unscrew the mixing chamber top. Remove the slide and needle assembly.



6. Nothing the presence, location and routing of all vent and overflow tubes, pull the carburetor toward you.



8. Remove the Phillips screws (4) holding float bowl to body. With carburetor in upright position, remove float chamber body. Pour float chamber body into suitable container.



9. Invert carburetor body and inspect float. Note its installation position.



10. Remove float pivot pin and float. If fuel has entered a float, or if the float is damaged in any fashion, replace.



11. Remove the inlet needle directly beneath the float arm tang. Inspect the needle and seat for signs of excessive wear or attached foreign particles. Replace as required. Always replace inlet needle and inlet valve seat as an assembly.



12. Remove, in order, the following components:

1. Main Jet



2. Pilot Jet



3. Main Nozzle



4. Throttle Screw (Idle Speed Screw)

5. Air Adjusting Screw (Idle Mixture Screw)

12. Push down on the Starter Jet lever to open the circuit.
13. Wash the carburetor in mild petroleum base solvent. Wash all associated parts.

NOTE: It is rarely necessary to "boil" the carburetor in a warm or hot carburetor bath. If deposits warrant this procedure, remove the Starter Jet Assembly to avoid damaging the jet's neoprene valve seat.

14. Using high pressure air, blow out all passages and jets.



NOTE: Never direct high pressure air into carburetor with float chamber body installed. Damage to floats may occur.

15. Re-install all components with the exception of the float chamber body.

16. Using a vernier caliper, measure the distance from the bottom of the float to the float chamber gasket surface (gasket removed).



Float Level: 23mm

NOTE: Hold the float so that tang is just resting on, but not depressing, the spring loaded inlet needle.

To correct float height, remove the assembly and bend the tang a slight amount as required. Both the right and left float sides should measure identically. Correct as required.

18. Install the float chamber body.

19. Moving to machine, push needle out of seat in throttle valve (slide). Inspect for signs of bending, scratches or wear. Replace if damages.

20. Check needle clip position. Clip position is counted starting with the first clip groove at the top of the needle.

Jet Needle Type:	049-2
Clip Position:	2

21. Check throttle valve (slide) for signs of wear. Insert into carburetor body and check for free movement. If slide, or body, is out of round causing slide to stick, replace as required.

22. Install throttle valve and needle assembly in carburetor mixing chamber. Tighten mixing chamber top as tight as possible by hand. Do not use pliers or vice-grips as they may deform the mixing chamber shape, causing the throttle valve to stick during operation.

23. Push down mixing chamber top cover and install all overflow and vent tubes. Re-install carburetor. Check position and routing of all tubes. Check tightness of all fittings. Make sure carburetor is mounted in a level position.

24. After installation, re-adjust throttle cable and Autolube pump cable per directions in "Mechanical Adjustments."

TROUBLESHOOTING

A Trials machine requires immediate, predictable throttle response over a wide operating range. Cylinder porting, combustion chamber compression, ignition timing, muffler design, and carburetor size and component selection are all balanced to achieve this goal. However, variations in temperature, humidity and altitude, to name a few, will affect carburetion and consequently, engine performance.

The following list gives each of the major components of the TY80A carburetor that can be readily changed in order to modify carburetor performance if required. If you are unfamiliar with carburetor theory, we suggest you refrain from making changes. Quite often, a performance problem is caused by another related component, such as the exhaust system, ignition timing or combustion chamber compression.

NOTE: See "Mechanical Adjustments" for additional carburetor adjustments.

IDLE AIR MIXTURE SCREW:

Controls the ratio of air to fuel in the idle circuit. Turning the screw in decreases the air supply giving a richer mixture. Normally, for Trials competition, the idle mixture screw is backed out to a lean position. OPERATING RANGE MOST AFFECTED BY THIS ADJUSTMENT: ZERO TO 1/8 THROTTLE.

PILOT JET:

Controls the ratio of fuel to air in the idle circuit. Changing the jet to one with a higher number supplies more fuel to the circuit giving a richer mixture. OPERATING RANGE MOST AFFECTED BY THIS JET: ZERO TO 1/8 THROTTLE.

THROTTLE VALVE (Slide):

The throttle valve (slide) has a portion of the base cut away to control air flowing over the main nozzle. A wider angle (more "cutaway") will create a leaner mixture. Throttle valves are numbered according to the angle of the cutaway. The higher the number, the more cutaway, the leaner the mixture. OPERATING RANGE MOST AFFECTED BY THE THROTTLE VALVE: 1/8 to 1/2 (+) THROTTLE.

JET NEEDLE:

The jet needle is fitted within the throttle valve. The tapered end of the needle fits into the main nozzle outlet. Raising the needle allows more fuel to flow out of the nozzle outlet giving a richer mixture. There are five circlip grooves at the top of the needle. Moving the needle clip from the first, or top groove, through the fifth, or bottom groove, will give a correspondingly richer mixture.

OPERATING RANGE MOST AFFECTED BY THE JET NEEDLE: 1/8 TO 3/4 (+) THROTTLE.

MAIN JET:

The main jet controls overall fuel flow through the main nozzle. Changing the jet to one with a higher number supplies more fuel to the main nozzle giving a richer mixture.

OPERATING RANGE MOST AFFECTED BY THE MAIN JET: 3/4 TO FULL THROTTLE.

NOTE: Excessive changes in main jet size can affect overall performance.

CAUTION

The fuel/air mixture ratio is a governing factor upon engine operating temperature. Any carburetor changes, whatsoever, must be followed by a thorough spark plug test.

REED VALVE

With carburetor removed, proceed as follows:

1. Remove oil line from fitting on manifold.
2. Remove the bolts (4) holding the intake manifold and reed valve assembly to cylinder. Remove assembly.



3. Inspect reed petals for signs of fatigue cracks. Reed petals should fit flush or nearly flush against neoprene seats. If in doubt as to sealing ability, apply suction to carburetor side of assembly. Leakage should be alight to moderate.

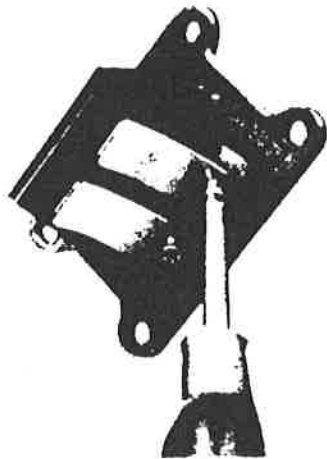
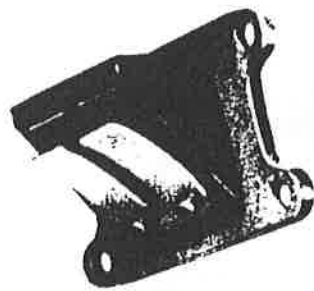

2. During reassembly, clean reed block, reed, and stopper plate thoroughly. Apply a holding agent, such as "Lock-Tite", to threads of Phillips screws. Tighten each screw gradually to avoid warping. Tighten the screws thoroughly.

NOTE: During reassembly, note the cut in the lower corner of the reed and stopper plate. Use as aid to direction of reed installation.

4. If disassembly of the reed valve assembly is required, proceed as follows:
 1. Remove Phillips screws (2) securing stopper plate and reed to reed block. Handle reed carefully. Avoid scratches and do not bend. Note from which side of the reed block the reed and stopper plate were removed. Re-install on same side.

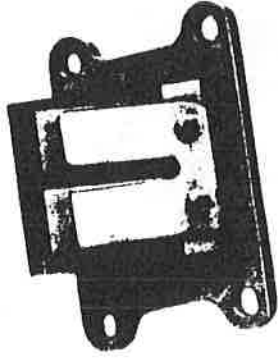

5. During reassembly of the reed valve assembly and manifold, install new gaskets and torque the securing bolts gradually and in pattern. Tighten thoroughly.

TOP END AND MUFFLER

With the carburetor removed, proceed as follows:

MUFFLER AND CYLINDER HEAD REMOVAL

1. Remove seat assembly.
2. Remove securing bolt at rear of fuel tank.



3. Lift rear of fuel tank up and pull back to clear frame mounts.



4. Remove bolt which secures rear of muffler to frame.

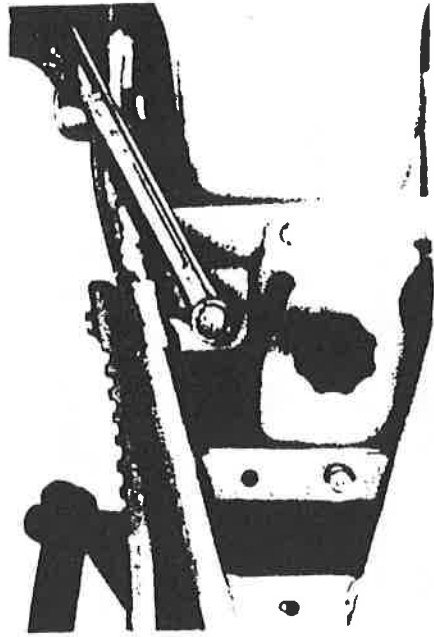

5. Using special ring nut wrench, remove ring nut holding muffler to cylinder. Remove muffler.

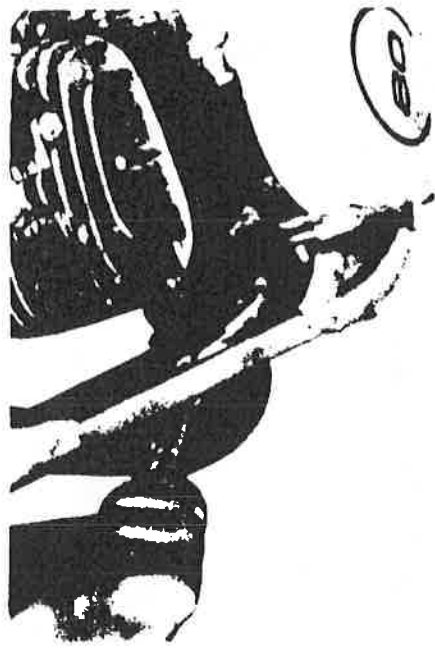

6. Remove spark plug lead wire. Loosen, but do not remove spark plug.



7. Remove nuts (4) securing cylinder head to cylinder.
Remove cylinder head and gasket.

NOTE: Break each nut loose (1/4 turn) prior to removing.

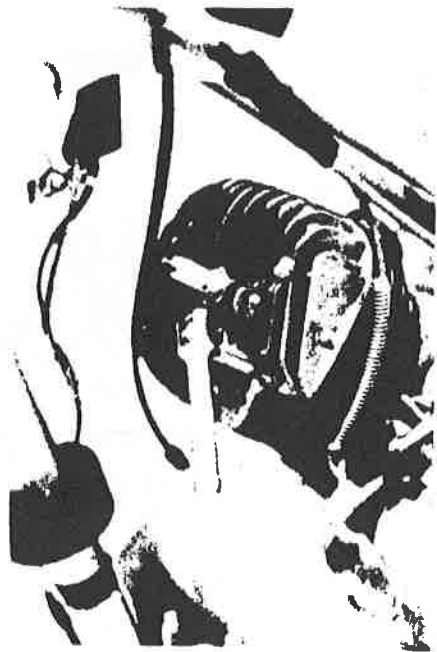

CYLINDER AND PISTON REMOVAL

1. With piston at Top Dead Center, raise cylinder until cylinder skirts clear crankcase. Stuff a clean shop rag into crankcase cavity, around rod, to prevent dirt and other foreign particles from entering. Remove cylinder.



2. Remove wrist pin clip (1) from piston. Push wrist pin out from opposite side. Remove piston.



MAINTENANCE – MUFFLER/SPARK ARRESTER

1. Using a rounded scraper, remove excess carbon deposits from manifold area of muffler. Check muffler gasket condition. The gasket seat is located around the cylinder exhaust port.
2. Carbon deposits within the muffler may be removed by lightly tapping the outer shell with a hammer and then blowing out with compressed air. Heavy wire, such as a coat hanger, may be inserted to break loose deposits. Use care.
3. Remove Phillips screw holding spark arrester in place. Remove spark arrester. Clean carbon from arrester assembly with scraper. Re-install.

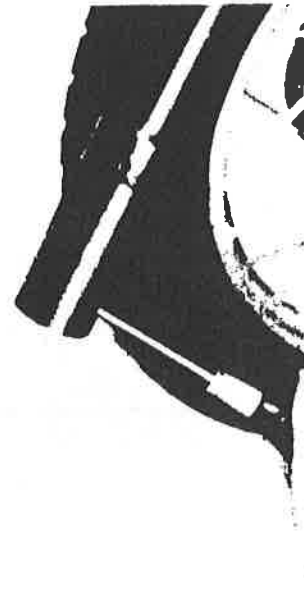

MAINTENANCE – CYLINDER HEAD

1. Remove spark plug.

2. Using a rounded scraper, remove carbon deposits from combustion chamber. Take care to avoid damaging the spark plug threads. Do not use a sharp instrument. Avoid scratching the material.



3. Place head on a surface plate. There should be no warpage. Correct by re-surfacing. Place 400-600 grit wet sandpaper on surface plate and re-surface head using a figure-eight sanding pattern. Rotate head several times to avoid removing too much material from one side.
4. Clean spark plug gasket mating surface thoroughly.
5. Wash head in solvent and wipe dry.
6. Install new cylinder head gasket during reassembly.

CYLINDER HEAD NUT TORQUE: 1.0kg-m (85in-lbs)

MAINTENANCE - CYLINDER

1. Using a rounded scraper, remove carbon deposits from exhaust port.



2. Remove cylinder base gasket and clean gasket seat on cylinder and crankcase thoroughly.
3. Check cylinder bore. Using a cylinder hone, remove any scoring. Hone lightly, using smooth stones. Hone no more than required to avoid excess piston clearance.

4. Using a cylinder gauge set to standard bore size, measure the cylinder. Measure at six points; at top, center, and $\frac{1}{2}$ " from bottom of skirts, in line with the wrist pin and at right angle to pin. Compare minimum and maximum measurements. If over tolerance, and not correctable by honing, re-bore to next over-size.

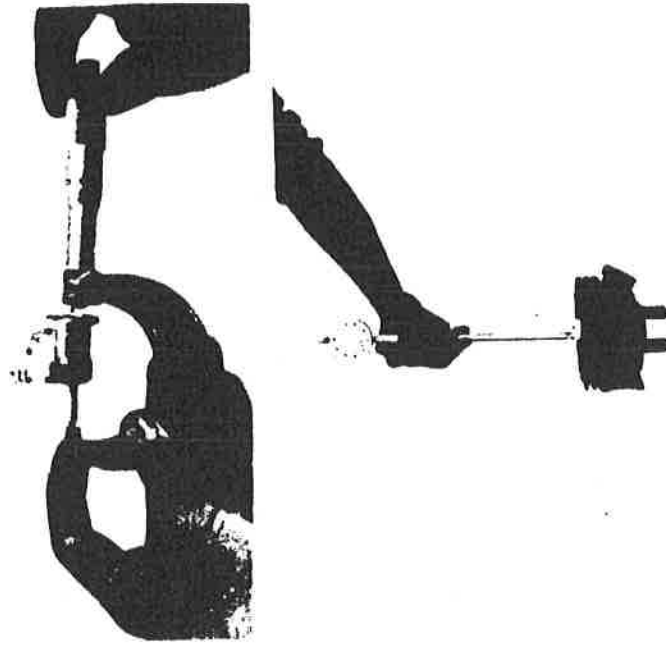

MAX. ALLOWABLE TAPER: 0.05mm
MAX. ALLOWABLE OUT-OF-ROUND: 0.005mm

MAINTENANCE – PISTON RINGS

1. Remove rings from piston. Remove ring expander from lower ring groove.

5. Wash cylinder thoroughly with soap and water.

Dry. Coat walls with light oil film immediately.

6. During re-assembly, always use a new cylinder base gasket.

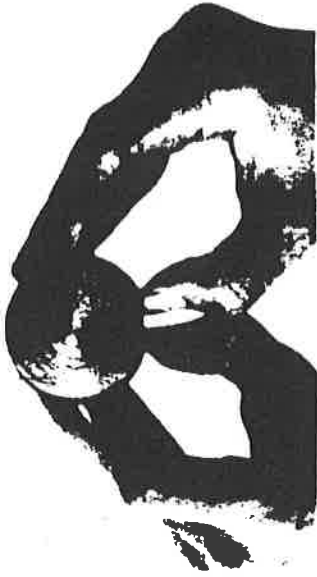

2. Check rings for scoring. If any severe scratches are noticed, replace set.

3. Measure ring end gap in free position. If beyond tolerance, replace set.

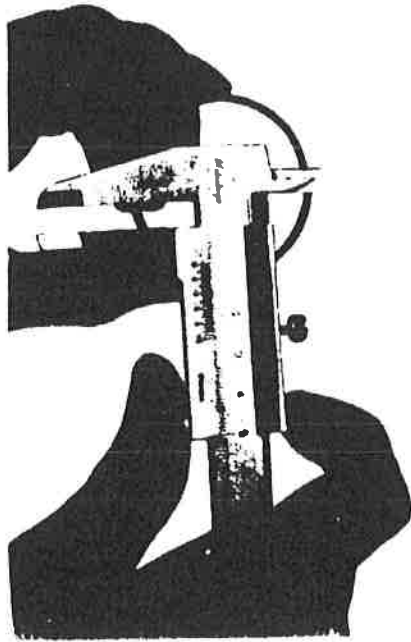

TOP RING END GAP, FREE	approx. 7.5mm
LOWER RING END GAP, FREE	approx. 4mm

4. Insert each ring into cylinder. Push down approximately $\frac{3}{4}$ " using piston crown to maintain right-angle to bore. Measure installed end gap. If beyond tolerance, replace set.

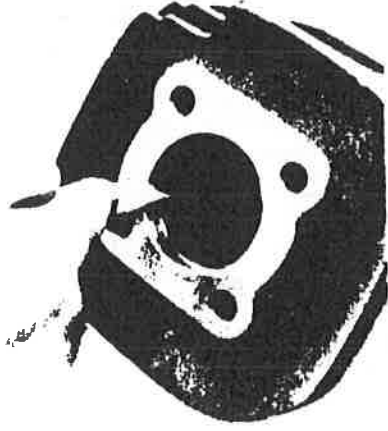

	MIN	MAX
TOP RING END GAP, INSTALLED	0.15 (mm)	0.35 (mm)
2ND RING END GAP, INSTALLED	0.15 (mm)	0.35 (mm)

5. Holding cylinder towards light, check for full seating of ring around bore. If not fully seated, check cylinder. If cylinder not out-of-round, replace it.

6. Check ring expander. If worn excessively, or broken, replace set.

7. With rings installed in grooves, insert feeler gauge between ring edge and groove. If beyond tolerance, replace ring and/or piston as required.

	MIN	MAX
2ND RING GROOVE CLEARANCE	0.03 (mm)	0.08 (mm)

9. During installation, make sure ring ends are properly positioned on either side of locating pin in ring groove. Make sure ring expander is positioned in like manner. Apply liberal coating of two-stroke oil to rings.

10. New rings require break-in. Follow first portion of new machine break-in procedure.

MAINTENANCE — PISTON

1. Using a rounded scraper, remove carbon deposits from piston crown.



2. Break a used piston ring in two. File end square. De-burr edges to avoid scratching ring groove and clean carbon deposits from ring grooves.



- Using 400-600 grit wet sandpaper, lightly sand scorch marks and lacquer deposits from sides of piston. Sand in cross-hatch pattern. Do not sand excessively.



Piston maximum diameter subtracted from minimum cylinder diameter gives piston clearance. If beyond tolerance, hone cylinder to tolerance or re-bore to next over-size and fit new piston.

- Wash piston in solvent and wipe dry.

- Using an outside micrometer, measure piston diameter. The piston is cam-ground and tapered. The only measuring point is at right-angles to the wrist pin holes about $\frac{1}{2}$ " from the bottom of the piston skirts. Compare piston diameter to cylinder bore measurements.

STANDARD PISTON DIA: 47mm

	MIN 0.0014	MAX 0.0216
NOMINAL PISTON CLEARANCE	0.035 (mm)	0.040 (mm)
MAXIMUM WEAR LIMIT	0.100 (mm)	

,004

6. During re-assembly, coat the piston skirt areas liberally with two-stroke oil.



7. Install new piston pin circlips and make sure they are fully seated within their grooves.



8. Take care during installation to avoid damaging the piston skirts against the crankcase as the cylinder is installed. Note the two induction holes in the piston skirt. These must be to the rear during installation.



9. Make sure the rings are properly positioned as the cylinder is installed.

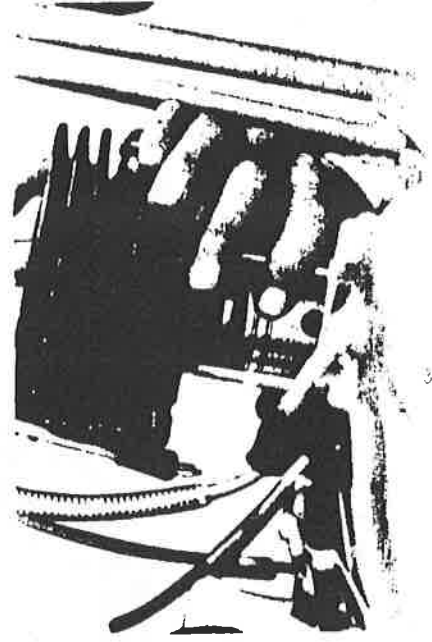

MAINTENANCE — PISTON PIN, BEARING AND CONNECTING ROD

1. Check the pin for signs of wear. If any wear is evident, replace pin and bearing.
2. Check the pin and bearing for signs of heat discoloration. If excessive (heavily blued), replace both.



3. Check the bearing cage for excessive wear. Check the rollers for signs of flat spots. If found, replace pin and bearing.

4. Apply a light film of oil to pin and bearing surfaces. Install in connecting rod small end. Check for play. There should be no noticeable vertical play. If play exists, check connecting rod small end diameter and wear. Replace pin and bearing or all as required.

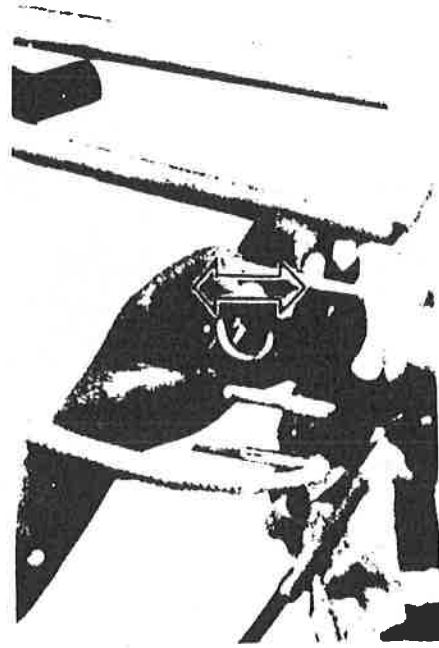

5. Rotate the crankshaft to top dead center. Mount a dial gauge at right angles to the connecting rod small end and measure axial play. (Hold bottom of rod to one side and rock top of rod from side to side.)



6. Remove the dial gauge and slide the connecting rod to one side. Insert a feeler gauge between the side of the connecting rod big end and the crank wheel. Measure clearance.

7. If any of these measurements exceed tolerance, crankshaft repair is required. Take the machine to your Authorized Dealer.

8. During reassembly, apply a liberal coating of two-stroke oil to the piston pin and bearing. Apply several drops of oil to the connecting rod big end. Apply several drops of oil into each crankshaft bearing oil delivery hole.



.078 .031

	Max	Min
Connecting rod axial play	2.0mm	0.8mm
Connecting rod/crank web clearance	0.5mm	0.4mm

.020 .016

TROUBLESHOOTING -- TOP END AND MUFFLER

If performance is not up to par, the following procedure will indicate if top end repair is required.

1. Adjust ignition timing.
2. Make a spark plug reading. Adjust spark plug and/or carburetion as required.
3. Decarbonize muffler/spark arrester assembly. Decarbonize cylinder head and piston crown. Take care that carbon does not drop into crankcase cavity or foul ring grooves. Reassemble.
4. Warm up engine. Insert compression gauge into spark plug hole. With ignition off and throttle on, kick engine over briskly several times. If compression measurement exceeds tolerances, disassemble cylinder head and decarbonize.
5. Reassemble and re-check compression pressure. If no improvement, disassemble top end complete.

	Nominal
COMPRESSION PRESSURE	5.5kg/cm ² (650-700r.p.m.)

IGNITION

NOTE: For timing procedure, see "Mechanical Adjustments, Ignition Timing." For theory of operation and troubleshooting, see "Electrical System."

1. Remove shift lever and left crankcase cover.
2. Disconnect clutch cable.
3. Remove the Flywheel Magneto securing nut, lock washer and flat washer. Note installation order and direction.

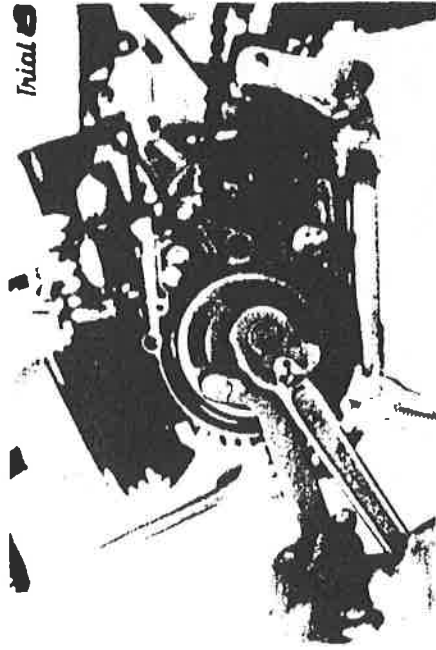

4. Install the Magneto Flywheel Puller.

NOTE: The puller body has a left-hand thread.

5. Tighten the puller body thoroughly into the flywheel. While holding the body, tighten the push bolt. This will pull the flywheel off the tapered end of the crankshaft.

NOTE: If the flywheel is frozen on the taper, keep pressure on the push bolt while tapping on the end of the bolt with a light steel hammer.



6. With the flywheel removed, the magneto backing plate is exposed, allowing for replacement of any assembly therein.
7. The Ignition source coil is located on the left hand side of the backing plate.

FLYWHEEL MAGNETO

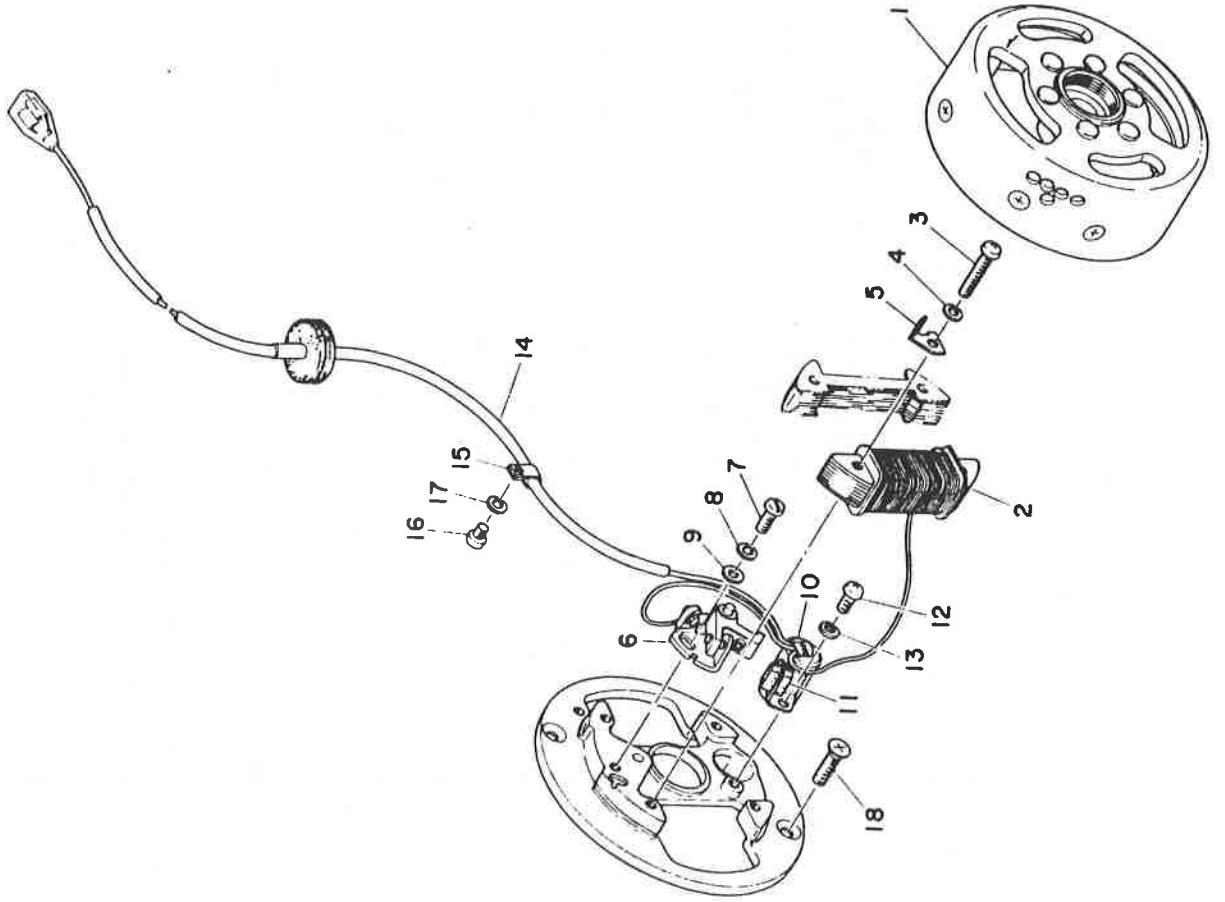

1. Rotor ass'y
2. Source coil
3. Panhead screw
4. Spring washer
5. Timing plate
6. Contact Breaker ass'y
7. Panhead screw
8. Spring washer
9. Plain washer
10. Condenser
11. Lubricator.
12. Panhead screw
13. Spring washer
14. Wire lead
15. Lead clamp
16. Panhead screw
17. Spring washer
18. Flathead screw

MAINTENANCE

1. Apply a few drops of light-weight machine oil or distributor lubricant to the point cam lubricating wick.

2. The ignition points can be lightly filed with an ignition point file or sanded with 400-600 grit sandpaper. Place a piece of clean paper between the points, let them close, and repeatedly remove the paper until no residue shows. The paper should be dipped in lacquer thinner or point cleaning fluid to provide a solvent to remove oil and sanding residue from point surfaces.

3. Point replacement should only occur when point gap exceeds maximum tolerance; when the points are severely pitted; or if the points become shorted or show faulty operation.

POINT GAP 0.3 ~ 0.4 mm

NOTE: There is no separate point gap adjustment. Point gap is directly related to ignition timing and cam follower wear. New points, when installed, should be lightly burnished and thoroughly cleaned per paragraph number two.

4. When replacing ignition condenser, source coil, or lighting source coil, soldering is required. Use a low wattage gun. Do not allow wiring to overheat as lacquer insulation on coil windings may be destroyed. The use of a heat sink is recommended.
5. When installing magneto to flywheel, make sure woodruff key is properly seated in keyway in crankshaft. Apply a light coating of lithium soap base grease to tapered portion of crankshaft end. Carefully install flywheel taking care to align for woodruff key. Install flat washer, lock washer and lock nut. Tighten carefully to recommended torque value.

Flywheel Securing Nut Torque: 3.5 ~ 4.0 kg-m
(300 ~ 350 in-lbs.)

NOTE: Whenever the Magneto Flywheel is removed, Ignition Timing must be reset.

CLUTCH, SHIFTER AND KICK STARTER

NOTE: Clutch adjustment is covered in Chapter VII, "Mechanical Adjustments."

1. Remove the kick start lever.
2. Remove footrest assembly to provide clearance for crankcase cover removal.
3. If cylinder is in place, remove oil pump delivery line from intake manifold.
4. Remove the Autolube pump cover.



5. Remove the clip and rotate the pump pulley to increase cable slack and remove the cable end from its seat in the pulley.



6. Using a 10mm wrench, loosen the cable adjuster locknut. Remove the adjuster and cable.



7. Remove the pivot shaft nut, loosen the footrest mounting nut, and turn the footrest ass'y so that don't touch crankcase cover. Remove the Allen bolts holding the side cover in place. Push down on the brake pedal to provide clearance and remove the cover.

NOTE: The Autolube pump assembly need not be removed for this procedure.

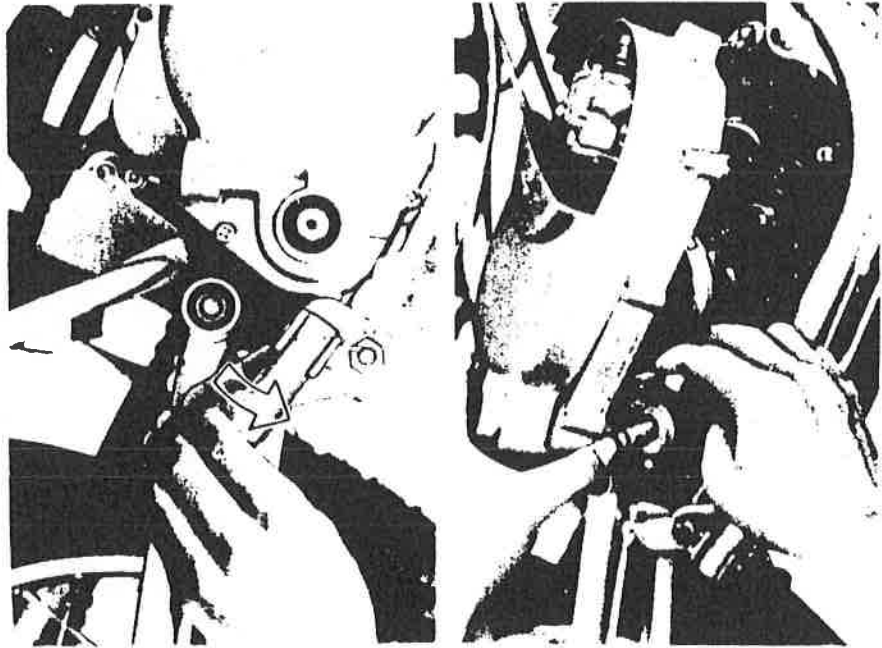

8. To remove kick start assembly, first disconnect return spring from post in case and allow it to unwind.

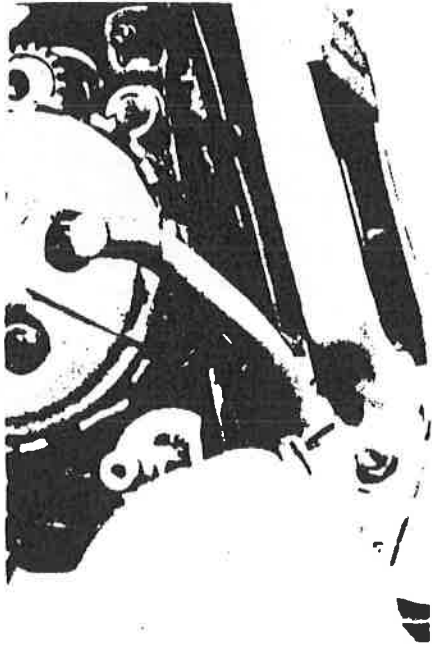

9. Pull out the kick starter assembly.

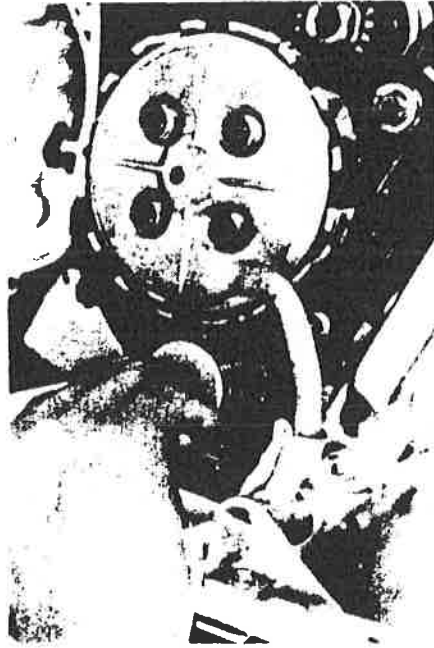

KICK STARTER

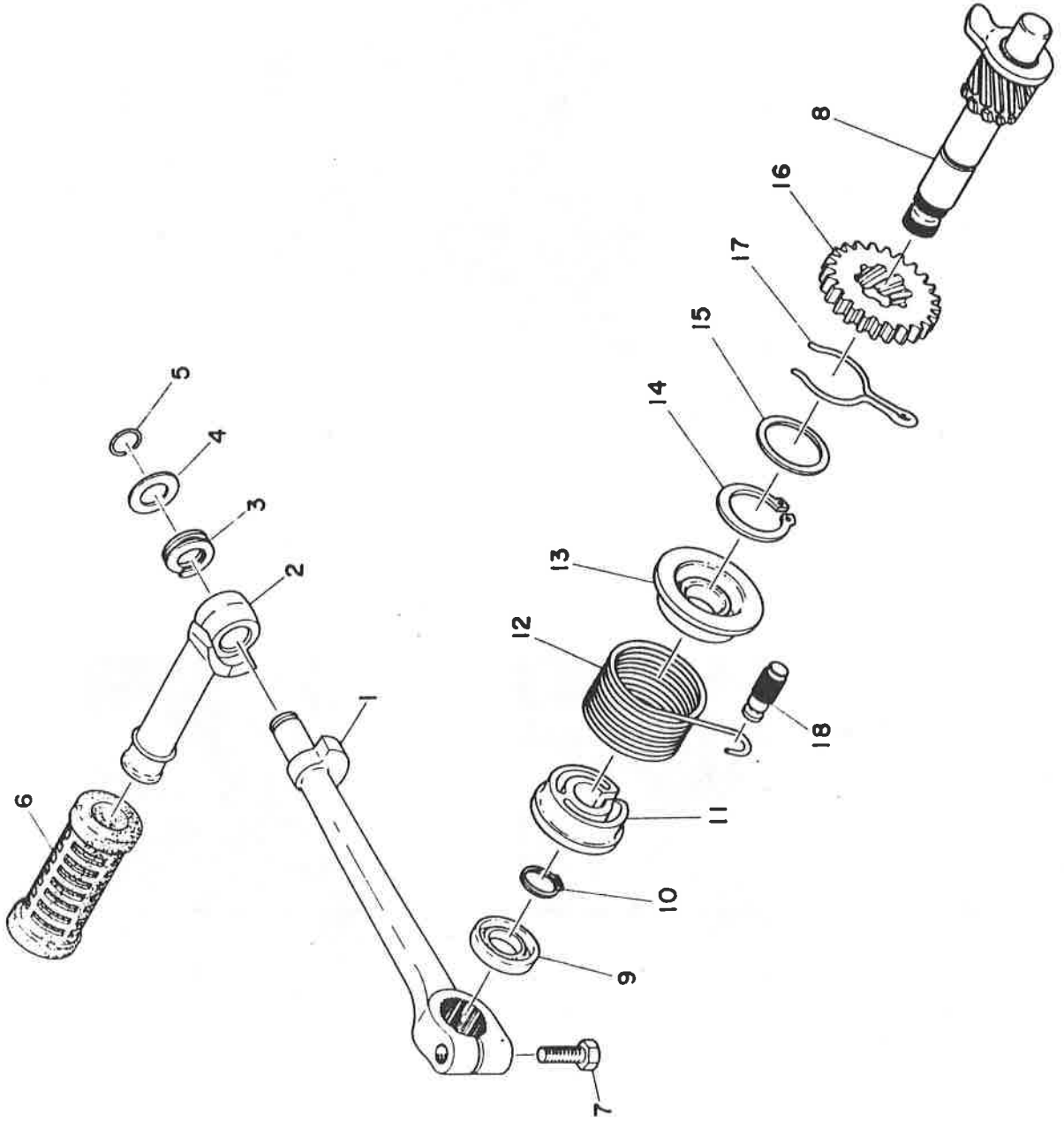

1. Kick crank
2. Kick lever
3. Kick crank spring
4. Kick lever washer
5. Kick lever clip
6. Kick lever cover
7. Bolt
8. Kick axle ass'y
9. Oil seal
10. Circlip
11. Kick spring cover
12. Kick spring
13. Kick spring guide
14. Circlip
15. Shim
16. Kick gear
17. Kick clip
18. Kick spring stopper

10. Remove the Phillips screws (4) holding the pressure plate. Remove the clutch springs, pressure plate and push rod. Remove the clutch plates, friction plates, and cushion rings.

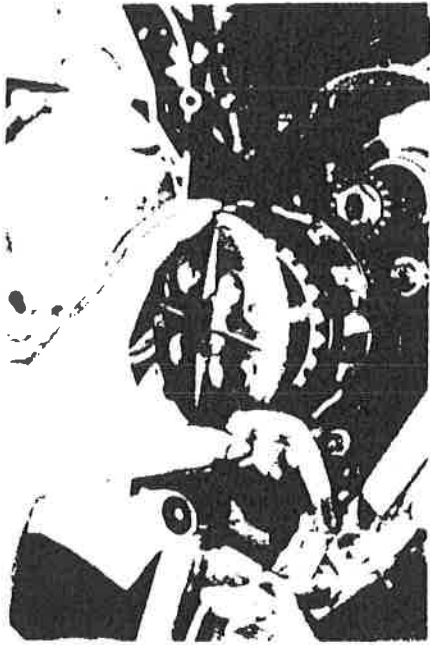

NOTE: When removing Phillips spring screws, loosen each screw in several stages working in a cross-hatch pattern to avoid any unnecessary warpage. Note the condition of each piece as it is removed and its location within the assembly.

11. Using the clutch holding tool, remove the clutch securing nut. Remove the clutch boss and driven gear (clutch housing).

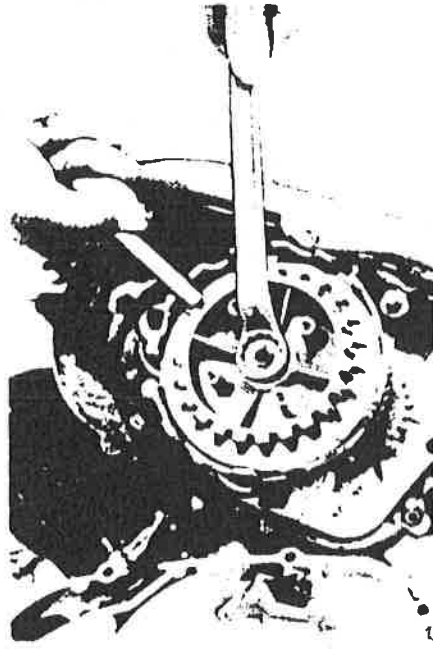

12. If the clutch housing spacer and thrust plate remain on the transmission main shaft, remove them.

TROUBLESHOOTING – CLUTCH ASSEMBLY

1. Measure the composition friction plates at three or four points. If their minimum thickness exceeds tolerance, replace.

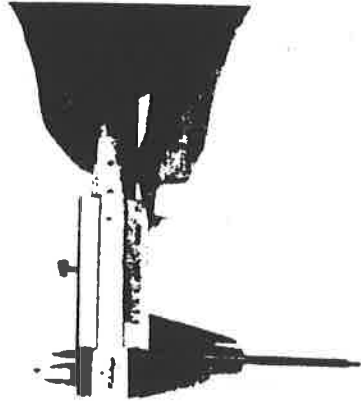

	NEW	WEAR LIMIT
FRICION PLATE THICKNESS	3.5mm	3.2mm

CLUTCH

1. Driven gear comp.
2. O-ring
3. Thrust plate 1
4. Thrust plate 2
5. Clutch boss
6. Cushion ring
7. Friction plate
8. Clutch plate
9. Pressure plate
10. Bolt
11. Clutch spring
12. Velleville wahser
13. Clutch boss nut
14. Push rod 1
15. Spacer
16. Ball
17. Push rod 2
18. Nut
19. Adjusting screw
20. Push screw
21. Push screw housing
22. Oil seal
23. Panhead screw
24. Push lever
25. Spring fork
26. Return lever spring

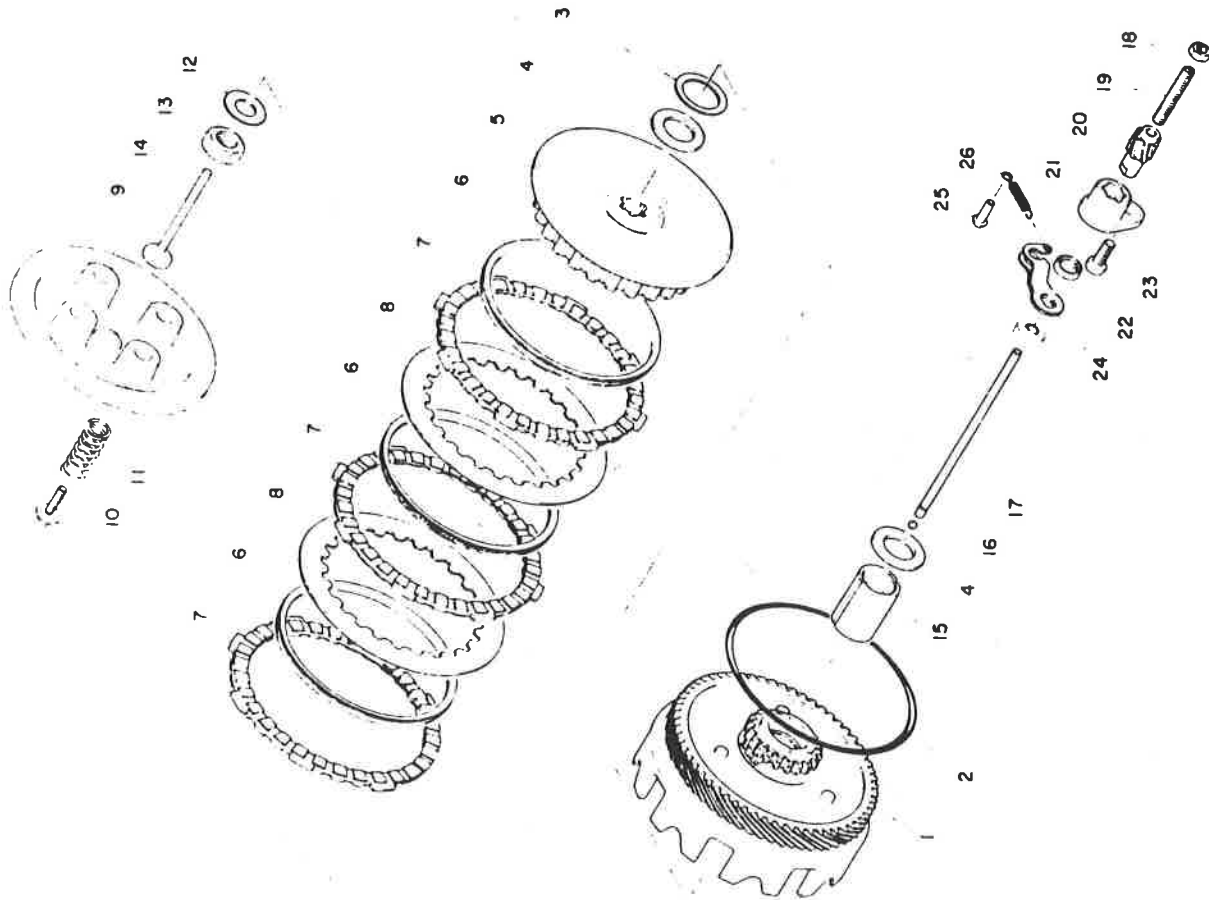

2. Check the plates for signs of warpage and heat damage, replace as required.

NOTE: For optimum performance, if any plate requires replacement, it is advisable to replace the entire set.

3. Check each clutch plate for signs of heat damage and warpage. Place on surface plate (plate glass is acceptable) and use feeler gauge as illustrated. If warpage exceeds tolerance, replace.



4. Thoroughly clean the clutch housing and spacer. Apply a light film of oil on the bushing surface and spacer. Fit the spacer into the bushing. It should be a smooth, thumb-press fit. The spacer should rotate smoothly within the bushing.



CLUTCH PLATE WARP ALLOWANCE	0.05mm MAXIMUM
-----------------------------	----------------

5. Check the bushing and spacer for signs of galling, heat damage, etc. If severe, replace as required.

6. Apply thin coat of oil on transmission main shaft and bushing spacer I.D. Slip thrust plate and spacer over main shaft. Spacer should fit with approximately same "feel" as in clutch housing. Replace as required.

7. Check dogs on driven gear (clutch housing). Look for cracks and signs of galling on edges. If moderate, deburr. If severe, replace.

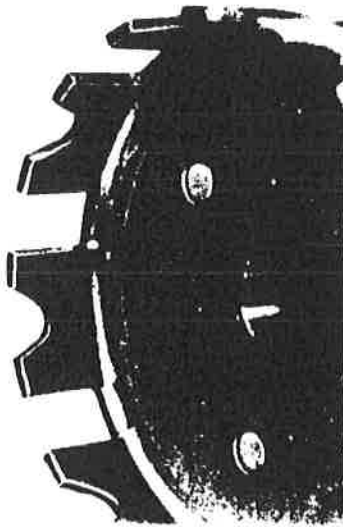

8. Check splines on clutch boss for signs of galling. If moderate, deburr. If severe, replace.

NOTE: Galling on either the friction plate dogs of the clutch housing or clutch plate splines of the clutch boss will cause erratic clutch operation.

9. Fit the clutch thrust plates (2) and clutch boss with a light film of oil on all parts. Check for smooth rotation. Check for signs of excessive wear, all parts. Replace as necessary.

10. If clutch operation has been abnormal, and the above procedures show no major failures, install the clutch housing on the transmission main shaft with thrust plates, bearing spacer, and clutch boss in their proper positions for reassembly. Do not install clutch or friction plates. Install Belleville spring and clutch securing nut. Torque to standard assembly value.

CLUTCH SECURING NUT TORQUE:

4.0~4.5kg-m
(350~400 in-lbs)

11. With transmission in neutral and primary driven gear stationary, clutch boss should turn without drag within the clutch housing. If housing does not turn easily, indicating insufficient housing end play, check all thrust plates for incorrect thickness. Correct by installing thinner thrust plates. Clutch housing end play is given in table and can be measured with a dial gauge.

	Nominal	Min	Max
Clutch Housing End Play	0.15 (mm)	0.10 (mm)	0.30 (mm)

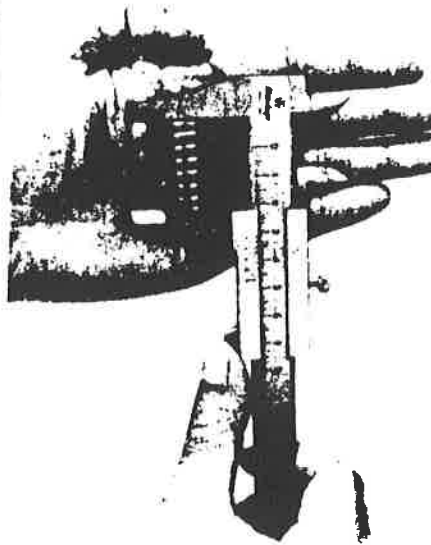

	New	Min
Clutch Spring Free Length	31.5mm	30.5mm

NOTE: For optimum clutch operation it is advisable to replace the clutch springs as a set if one or more are faulty.

13. Set the clutch spring set on a level surface. Rotate each spring until all are at approximately the same vertical angle and maximum apparent height. Place straight edge across set. If any spring exceeds tolerance, replace that spring.

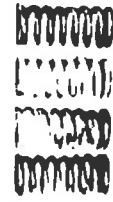

Clutch Spring Set Maximum Length Difference	1.0 mm
---	--------

14. During installation of the clutch assembly, do not allow the cushion rings to become twisted. Take care that the thrust plates do not slip out of position as the housing and clutch boss are installed. Install all parts with a heavy coat of 10W-30 motor oil on their mating surfaces.

CLUTCH SECURING NUT TORQUE: 4.0 ~ 4.5kg-m
(350 ~ 400 in-lbs)

SHIFT MECHANISM

NOTE: Shifter maintenance and adjustment should be performed with clutch assembly removed.

1. Remove the "E" clip securing change lever number two. Push down on change lever number three and remove the assembly.



2. Check the levers, pivots and springs for damage or wear and replace as required.
3. Turn change shaft in case. It must not bind or catch.
4. If it does, remove and file off any burrs or straighten if bent. Replace if damage is too extensive.

5. Remove shift cam stopper bolt, spring and detent from top, left-hand side of crankcase.
6. With the rear wheel off the ground, rotate the clutch shaft with one hand and turn the shift drum from lock to lock with the other hand. If the transmission doesn't shift through all gears smoothly, the engine should be disassembled and the transmission checked.

SHIFTER 2

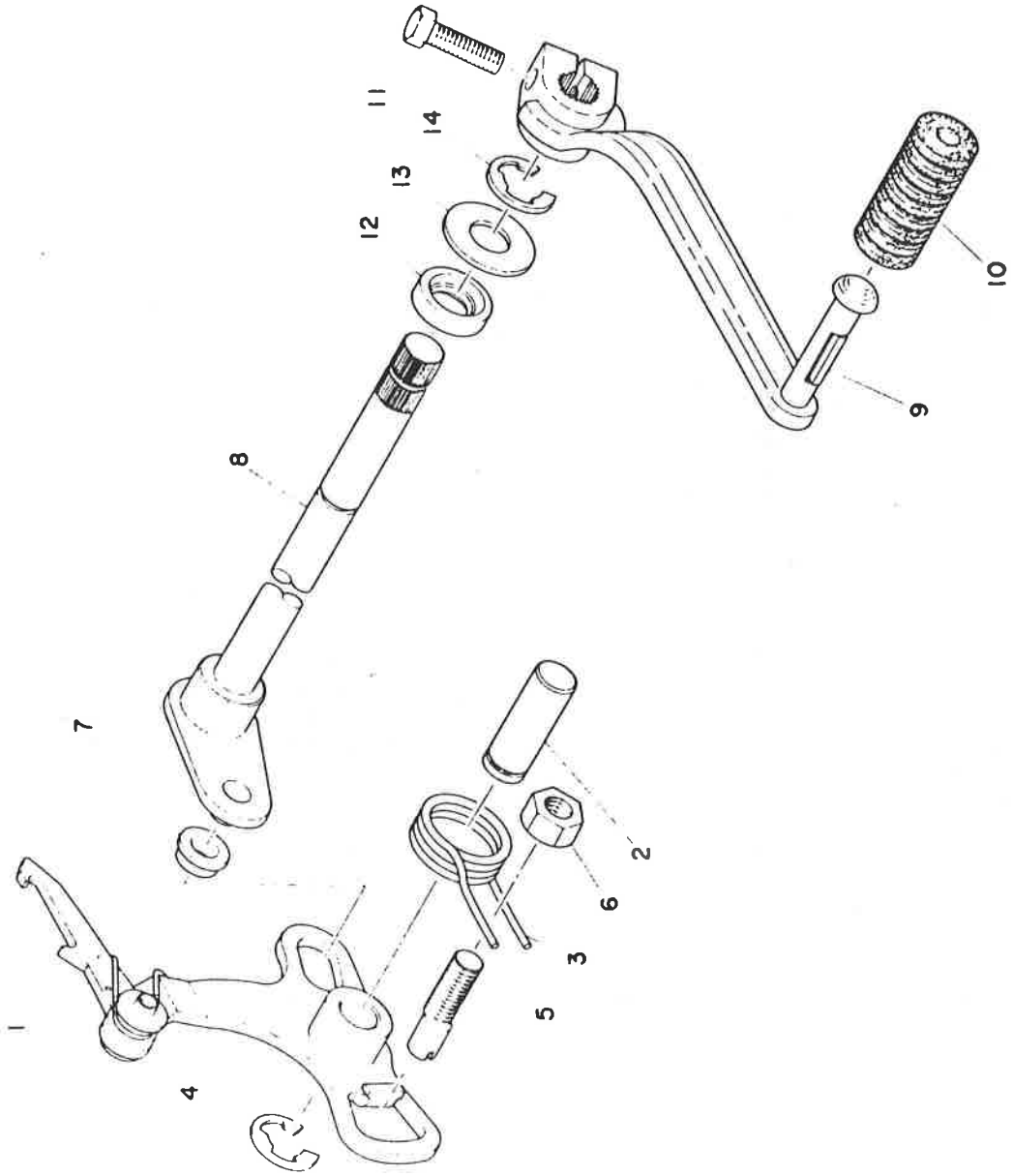

1. Change lever ass'y
2. Shaft
3. Shaft return spring
4. Circlip
5. Adjusting screw
6. Nut
7. Change lever roller
8. Change shaft ass'y
9. Change pedal
10. Change pedal cover
11. Bolt
12. Oil seal
13. Change axle washer
14. Circlip

ADJUSTMENT

1. In 2nd gear, check for proper centering. Change adjustment on screw as required.
3. While arm is butted against adjusting screw, measure clearance between Change Lever and shift drum dowel pin.
4. Repeat steps (2) and (3) shifting from 3rd - 2nd. Clearance must equal (3) above. Change adjustment using screw as required.
5. Repeat Step (1).

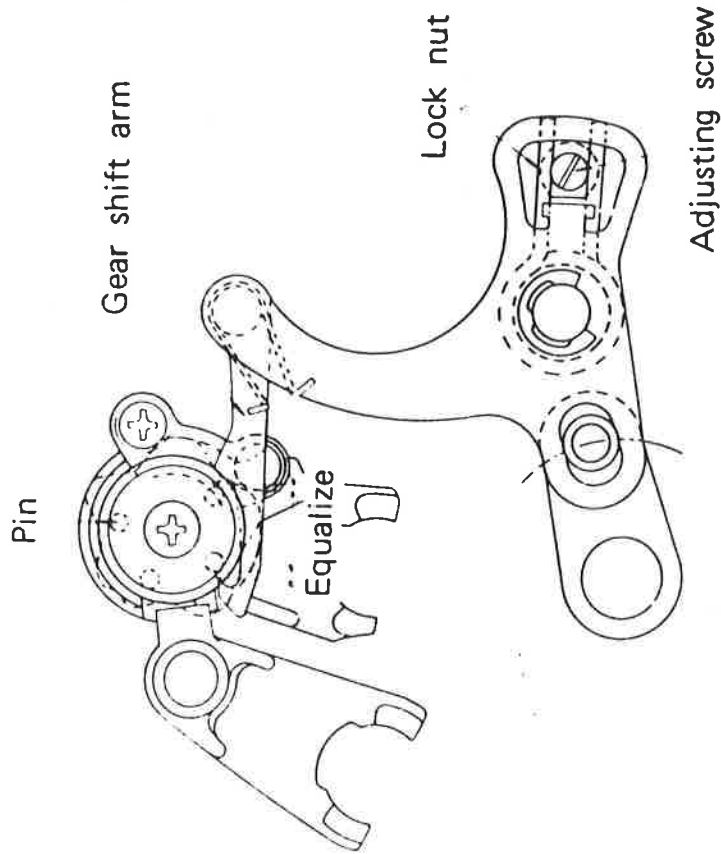

DRIVE SPROCKETS AND CHAIN

NOTE: Please refer to Maintenance Intervals and Lubrication Intervals charts for additional information.

DRIVE SPROCKET

With the left crankcase cover removed, proceed as follows:

1. Using a blunt chisel, flatten the drive sprocket lock washer tab.



2. With the drive chain in place, transmission in gear, firmly apply the rear brake. Remove the sprocket securing nut. Remove the sprocket.

3. Check sprocket wear. Replace if wear decreases tooth height to a point approaching the roller center line.

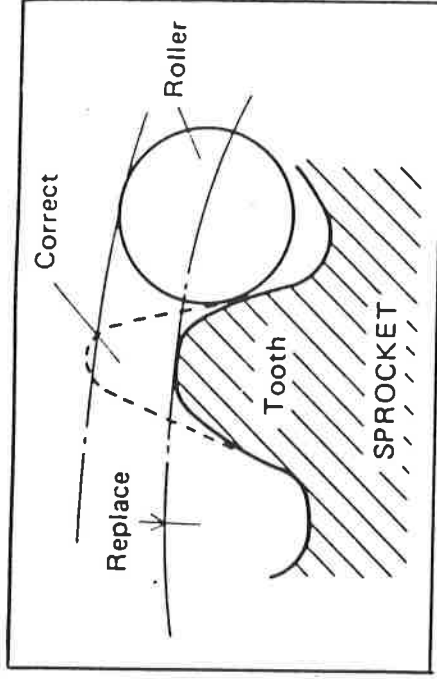

4. Replace if tooth wear shows a pattern such as that in the illustration, or as precaution and common sense dictate.

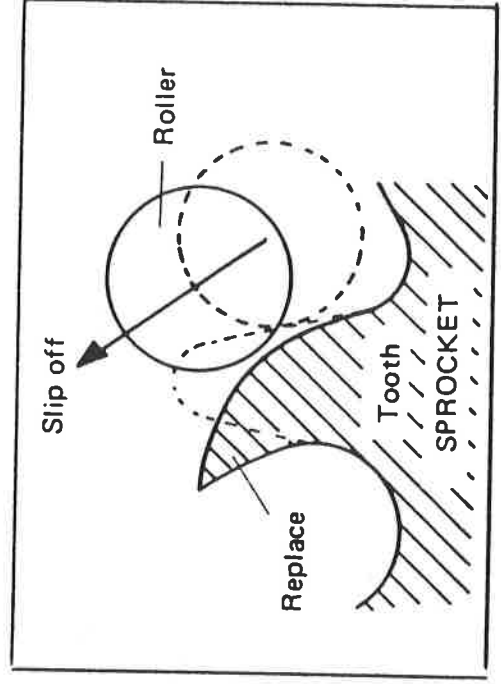

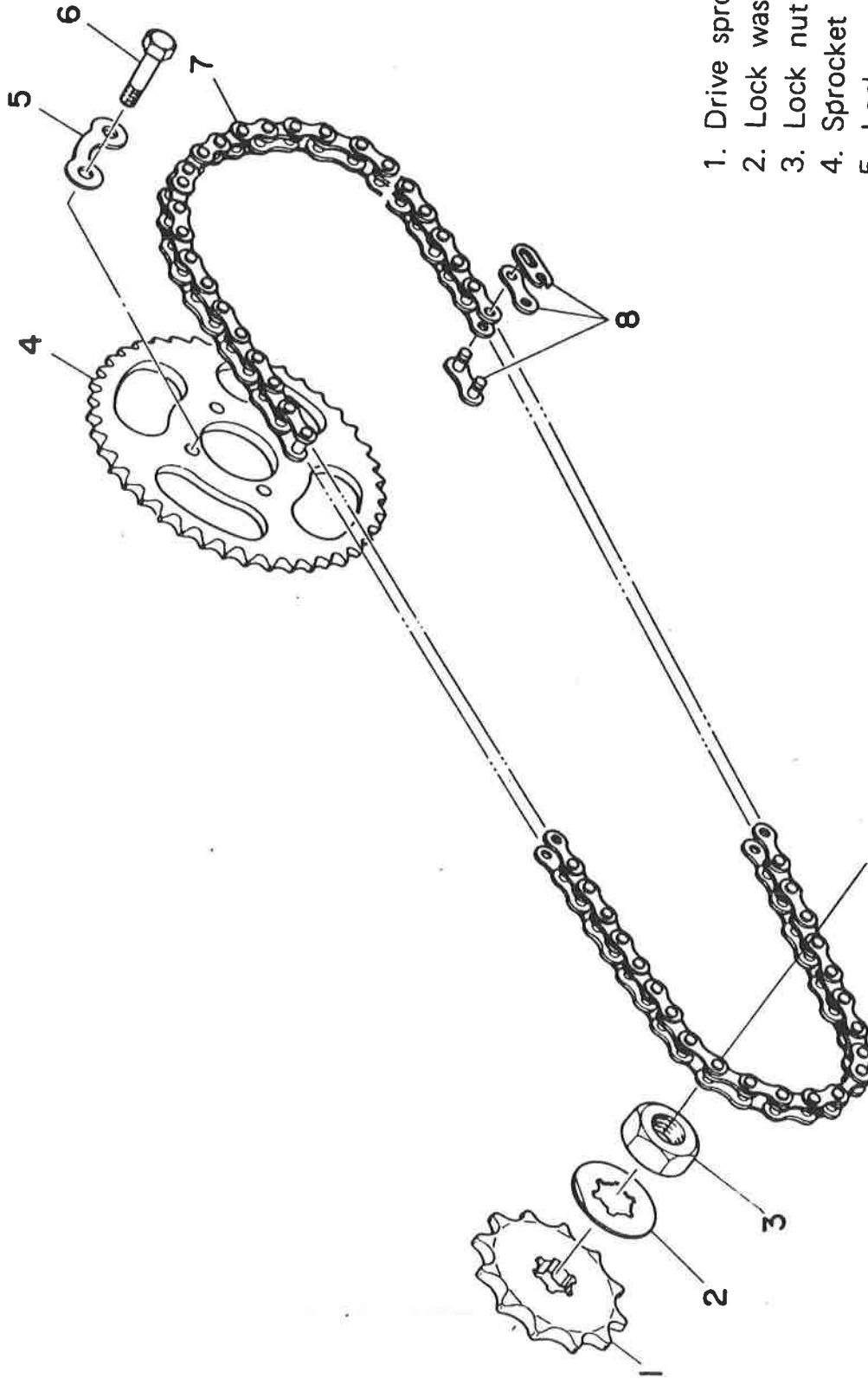

1. Drive sprocket
2. Lock washer
3. Lock nut
4. Sprocket wheel gear
5. Lock washer
6. Fitting bolt
7. Chain
8. Chain joint

5. During drive sprocket reassembly, make sure the lock washer splines are properly seated on the drive shaft splines. Tighten securing nut thoroughly to specified torque value. Bend lock washer tab fully against securing nut flats.

Drive Sprocket Securing Nut Torque: 4.0 - 4.5kg-m
(350 - 40-in-lbs)

DRIVEN SPROCKET

With the rear wheel removed, proceed as follows:

1. Using a blunt chisel, flatten the securing bolt lock washer tabs. Remove the securing bolts (4). Re-move the lock washers and sprocket.
2. Check sprocket wear per procedures for the drive sprocket.
3. During reassembly, make sure the sprocket and sprocket seat are clean. Tighten the securing bolts in a cross-hatch pattern. Bend the tabs of the lock washers fully against the securing bolt flats.

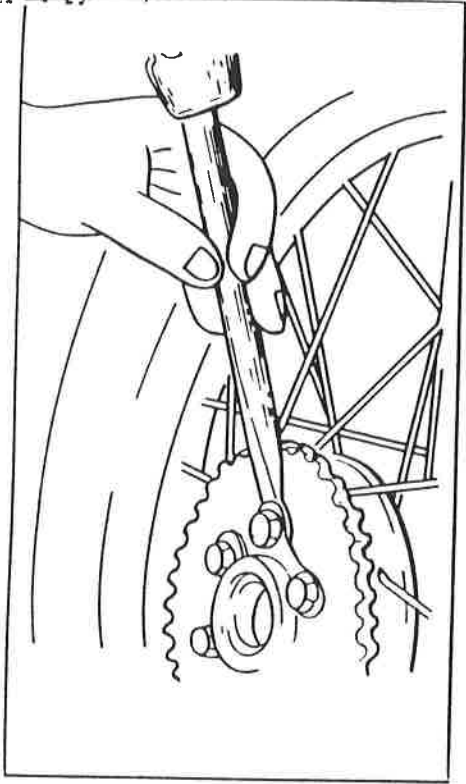

Driven Sprocket Securing Bolt Torque: 2.0 kg-m
(175 in-lbs)

CHAIN

NOTE: Please refer to Maintenance and Lubrication Intervals charts for additional information.

1. Using a blunt-nosed pliers, remove the master link clip and side plate. Remove the chain.

2. Check the chain for stiffness. Hold as illustrated. If stiff, soak in solvent solution, clean with medium bristle brush, dry with high pressure air. Oil chain thoroughly and attempt to work out kinks. If still stiff, replace.

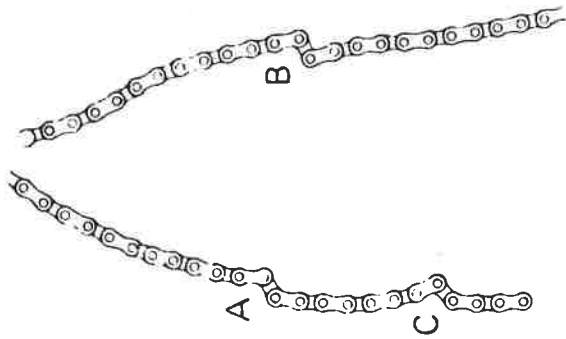

4. During reassembly, the master link clip must be installed with the rounded end facing the direction of travel.

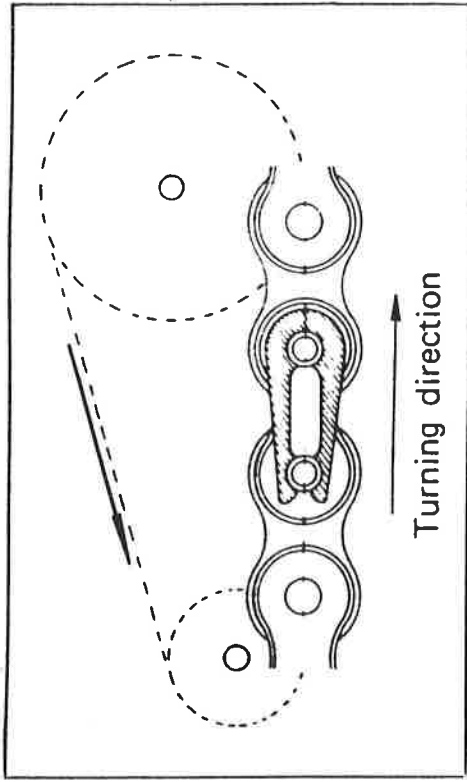

3. Check the side plates for visible wear. Check to see if excessive play exists in pins and rollers. Check for damaged rollers. Replace as required.

TROUBLESHOOTING

With the chain installed on the machine, excessive wear may be roughly determined by attempting to pull the chain away from the rear sprocket. If the chain will lift away more than one-half the length of the sprocket teeth, remove and inspect.

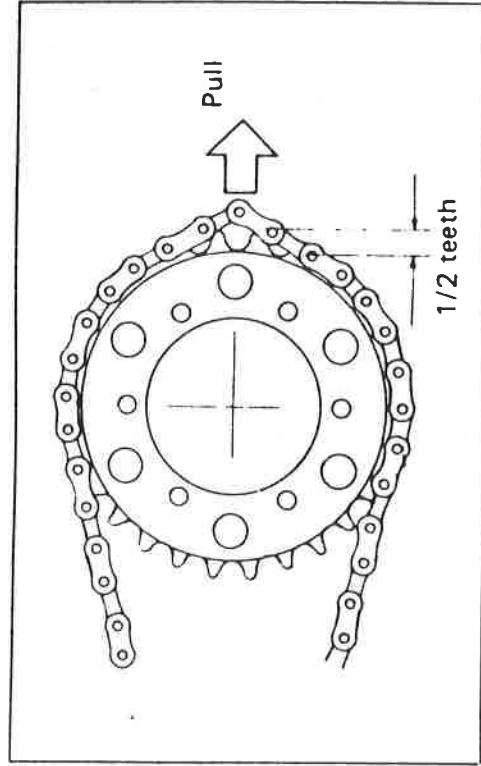

If any portion of the chain shows signs of damage, or if either sprocket shows signs of excessive wear, remove and inspect.

MAINTENANCE

The chain should be lubricated per the recommendations given in the Maintenance and Lubrication Intervals charts. More often if possible. Preferably after every use. See "Chassis and Suspension, Swing Arm", for additional information regarding chain guide and oiler.

1. Wipe off dirt with shop rag. If accumulation is severe, use soft bristle brush, then rag.
2. Apply lubricant between roller and side plates on both inside and outside of chain. Don't skip a portion as this will cause uneven wear. Apply thoroughly. Wipe off excess.

NOTE: Chain and lubricant should be at room temperature to assure penetration of lubricant into rollers.

Choice of lubricant is determined by use and terrain. SAE 20wt. or 30wt. may be used, but several specialty types by accessory manufactures offer more penetration, corrosion resistance and shear strength for roller protection.

In certain areas, semi-drying lubricants are preferable. These will resist picking up sand particles, dust, etc. Consult your Authorized Yamaha Dealer.

3. Periodically, remove the chain. Wipe and/or brush excess dirt off. Blow off with high pressure air.
4. Soak chain in solvent, brushing off remaining dirt. Dry with high pressure air. Lubricate thoroughly while off machine. Work each roller thoroughly to make sure lubricant penetrates. Wipe off excess. Re-install.

CABLES

NOTE: See Maintenance and Lubrication Intervals Charts for additional information.

Cable maintenance is primarily concerned with preventing deterioration through rust and weathering; and providing for proper lubrication to allow the cable to move freely within its housing.

Cable removal is straight-forward and uncomplicated. Removal will not be discussed within this section. For details, see the individual maintenance section for which the cable is an integral part.

Cable routing is of paramount importance, however. For details of cable routing, see the cable routing diagrams at the end of this manual.

MAINTENANCE

1. Remove the cable.
2. Check for free movement of the cable within its housing. If movement is obstructed, check for fraying of the cable strands. If fraying is evident, replace the cable assembly.
3. To lubricate cable, hold in vertical position. Apply lubricant to uppermost end of cable. Leave in vertical position until lubricant appears at bottom end. Allow excess to drain and re-install.

NOTE: Choice of lubricant depends upon conditions and preference. However, a semi-drying, graphite-base lubricant will probably perform most adequately under most conditions.

Under certain conditions, a water displacing lubricant is more suitable. Check with the Authorized Yamaha Dealer in your area.

THROTTLE CABLE CYLINDER

The throttle cable cylinder (junction point for Autolube control cable) must be periodically maintained also.

1. Remove throttle cable number one from handlebar housing.
2. Remove throttle cable number two from carburetor mixing chamber top.
3. Remove Autolube pump cable from pump pulley. Remove cable adjuster.
4. Remove seat and fuel tank.
5. Remove cable/cylinder assembly complete.
6. Remove cylinder cap, throttle cable two and Autolube pump cable.
7. Wash assembly thoroughly in solvent.
8. Lubricate all associated cables.
9. Apply a thin coating of lubricant to cylinder walls.

NOTE: A small amount of lithium soap base grease may be used in lieu of cable lubricant. However, if machine is to be used in extreme cold, this should be avoided.

10. Reassemble all cables. Make sure cylinder is sealed from ravages of weather and riding conditions. Reinstall. See cable routing diagrams for correct installation position. See Mechanical Adjustments Chapter for correct cable adjustment.

HANDLE · WIRE

1. Handle
2. Grip left
3. Grip right
4. Guide tube
5. Throttle wire
6. Cylinder
7. Throttle wire 2
8. Pump wire
9. Clutch wire
10. Wire end
11. Brake wire
12. Wire adjusting nut
13. Wire adjusting bolt
14. Grip cap upper
15. Grip cap under
16. Pan head screw
17. Lever left
18. Lever right
19. Pan head screw
20. Lever collar
21. Nut
22. Lever fitting screw
23. Pan head screw

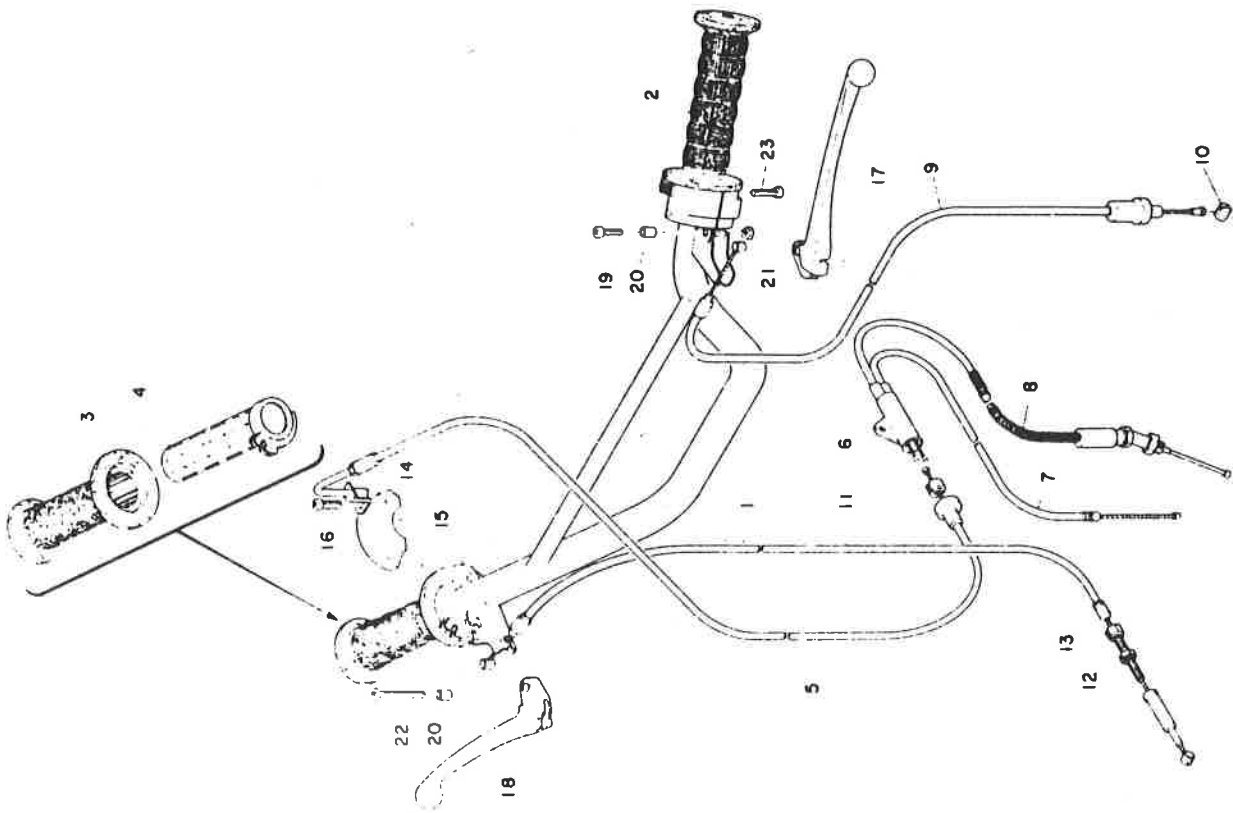

CAPTER IX CHASSIS AND SUSPENSION

1. WHEELS AND TIRES

1. Front Wheel

1. Removal

1. Disconnect the brake cable.

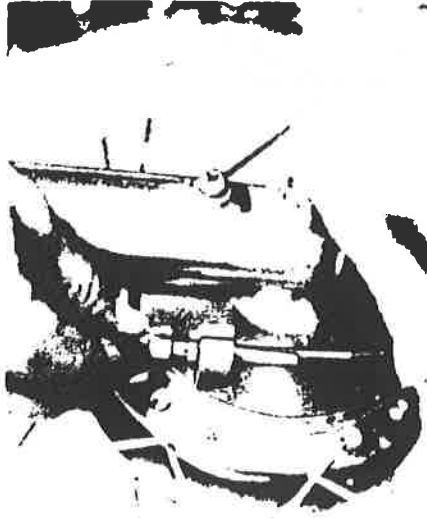

2. Remove cotter pin from front wheel nut

3. Remove the front wheel nut.



FRONT WHEEL

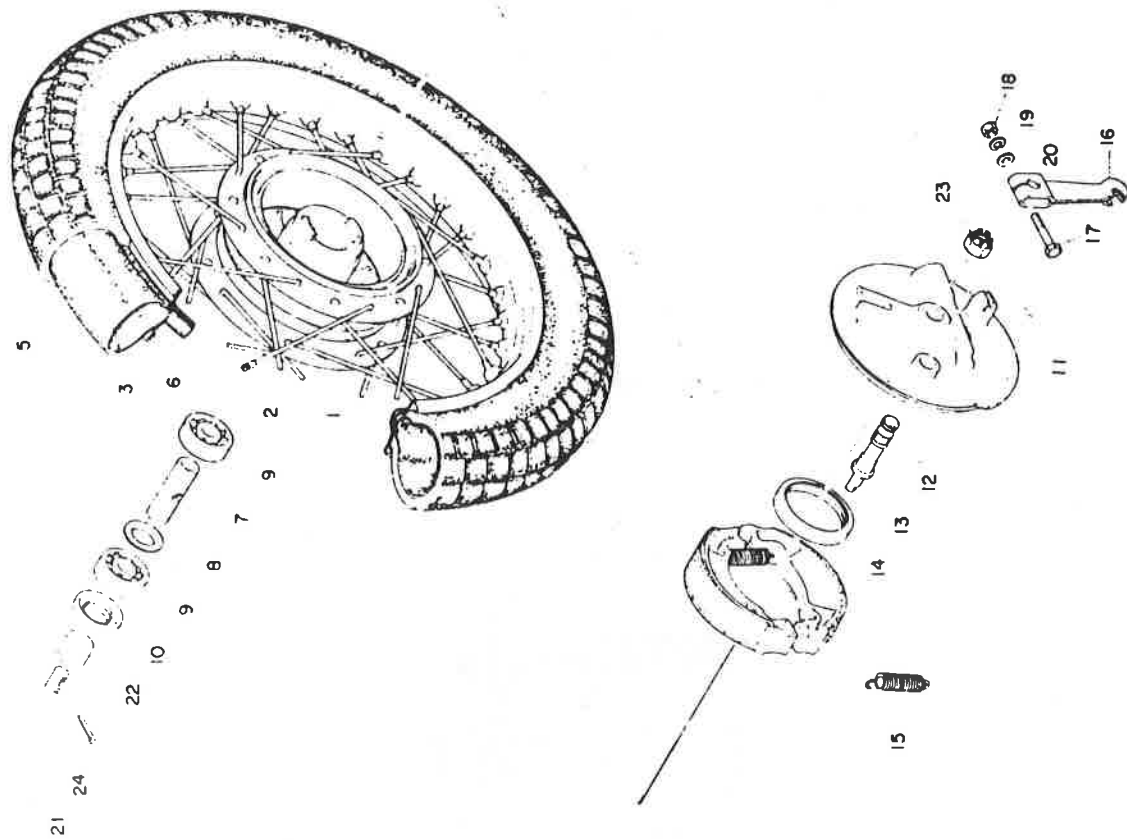

1. Front hub
2. Spoke set
3. Rim
4. Tire
5. Tube
6. Rim band
7. Bearing spacer
8. Spacer flange
9. Bearing
10. Oil seal
11. Brake shoe plate
12. Cam shaft
13. Oil seal
14. Brake shoe comp.
15. Return spring
16. Cam shaft lever
17. Bolt
18. Nut
19. Spring washer
20. Plain washer
21. Wheel shaft
22. Wheel shaft collar
23. Shaft nut
24. Cotter pin

4. Remove the front wheel axle by simultaneously twisting and pulling out on the axle.

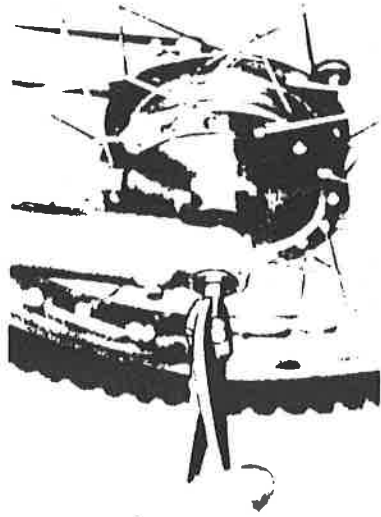

5. Raise the front of the machine and set it on a box. Then remove the wheel assembly.

2. Checking Brake Shoe Wear

1. Measure the outside diameter at the brake shoe with slide calipers. If it measures less than specified replace.

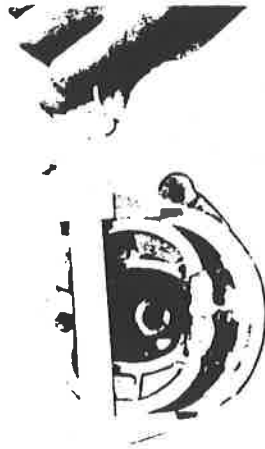

FRONT BRAKE SHOE DIAMETER: 95mm
REPLACEMENT LIMIT: 90mm

2. Brake Drum

Oil or scratches on the inner surface of the brake drum will impair braking performance or result in abnormal noises. Remove oil by wiping with a rag soaked in lacquer thinner or solvent. Remove scratches by lightly and evenly rubbing with emery cloth.

3. Replacing Wheel Bearings

If the bearings allow excessive play in the wheel or if it does not turn smoothly, replace the bearing as follows:

1. First clean and outside of the wheel hub.

2. Insert the bend end of the special tool into the hole located in the center of the bearing spacer, and drive the spacer out from the hub by tapping the other end of the special tool with a hammer. (Both bearing spacer and spacer flange can easily be removed.)

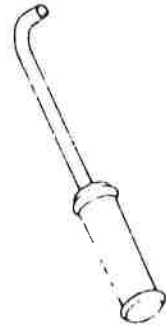

3. Push out the bearing on the other side.
4. To install the wheel bearing, reverse the above sequence. Be sure to grease the bearing before installation and use the bearing fitting tool (furnished by Yamaha).
5. Check the lips of the seals for damage or warpage. Replace if necessary.

2. Rear Wheel

The rear wheel is 14-in. size, and the rear tire is Trials Universal. A single leading-shoe type brake is used. A labyrinth seal between the wheel hub and the brake plate is provided to prevent water and dust leakage.

1. Removal

1. Remove the tension bar and brake rod from rear shoe plate.

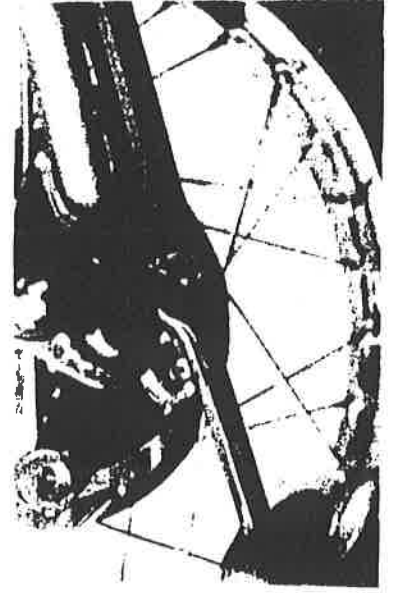
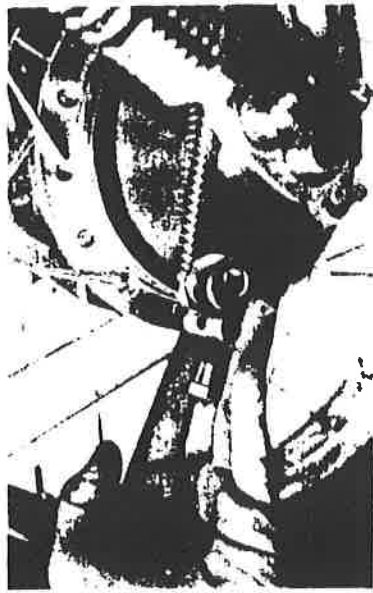

2. Remove cotter pin from rear wheel shaft nut.



3. Remove the rear wheel shaft nut.
4. Pull out the rear wheel shaft by simultaneously twisting and pulling out.

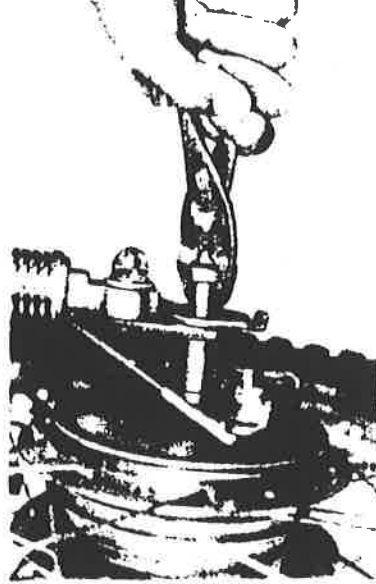

5. Remove the rear brake shoe plate.
6. Lean the machine to the left and remove the rear wheel assembly.

REAR WHEEL

1. Rear hub
2. Spoke set
3. Rim
4. Tire
5. Tube
6. Rim band
7. Bearing spacer
8. Spacer flange
9. Bearing
10. Oil seal
11. Brake shoe plate
12. Shift cam
13. Brake shoe comp.
14. Return spring
15. Cam shaft lever
16. Bolt
17. Nut
18. Spring washer
19. Plain washer
20. Tension Bar
21. Tension bar bolt
22. Spring washer
23. Nut
24. Cotter pin
25. Plain washer
26. Cotter pin
27. Wheel shaft
28. Chain puller
29. Wheel shaft cotter
30. Sprocket wheel gear
31. Fitting bolt
32. Lock washer
33. Nut
34. Oil seal
45. Shaft collar
36. Shaft nut
37. Cotter pin
38. Chain
39. Chain joint

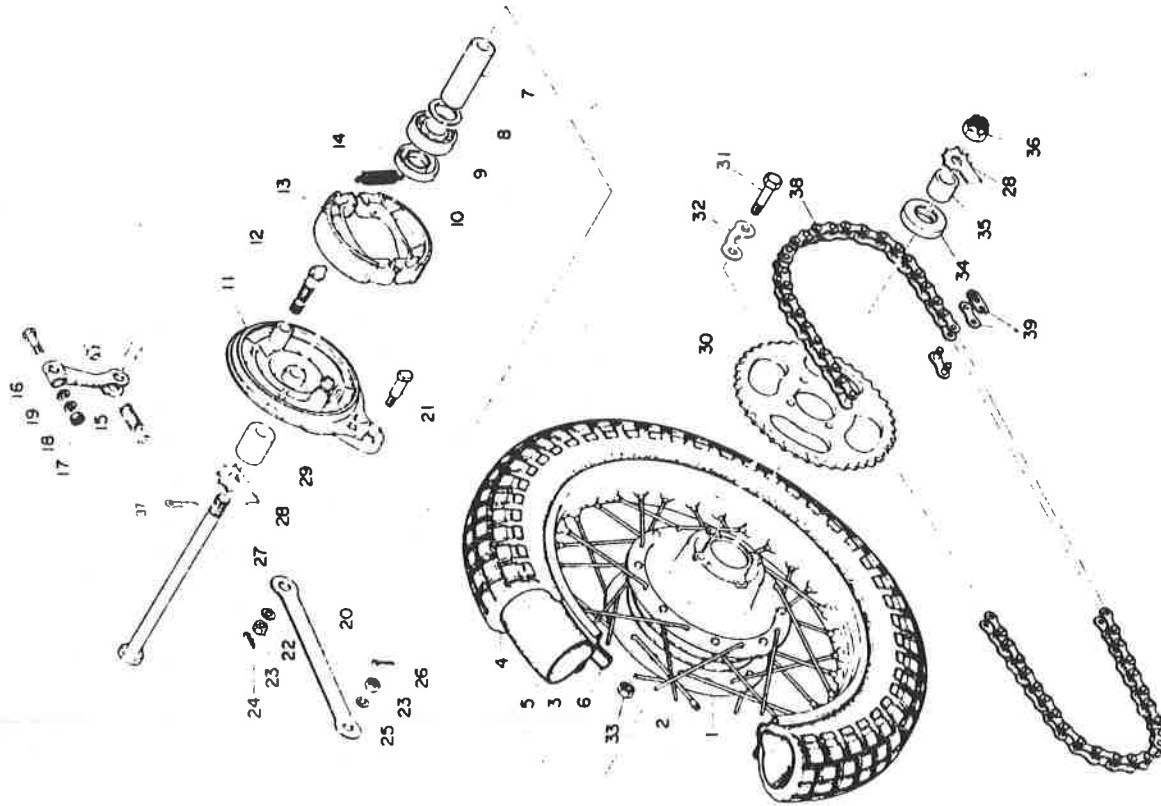

2. Checking Brake Shoe Wear

1. Measure the outside diameter at the brake shoe with slide calipers. If it measures less than specified replace it.



REAR BRAKE SHOE DIAMETER:	110mm
REPLACEMENT LIMIT:	105mm

2. Smooth out a rough shoe surface with sandpaper or with a file.

3. Brake Drum

Oil or scratches on the inner surface of the brake drum will impair braking performance or result in abnormal noises. Remove oil by wiping with a rag soaked in lacquer thinner or solvent. Remove scratches by lightly and evenly rubbing with emery cloth.

4. Replacing Wheel Bearings.

See front wheel section.

5. Spokes

Check the spokes. If they are loose or bent, tighten or replace them. If the machine is ridden in rough country often, or raced, the spokes should be checked regularly.

6. Rear Wheel Sprocket

1. Inspection

A worn sprocket will result in excessive chain noise and shorten the life of the chain. Check the sprocket for worn teeth, and replace sprocket if they are worn.

2. To replace the sprocket, take the following steps.

1. Bend the lock washer ears flat.



2. Remove the sprocket fitting bolts.

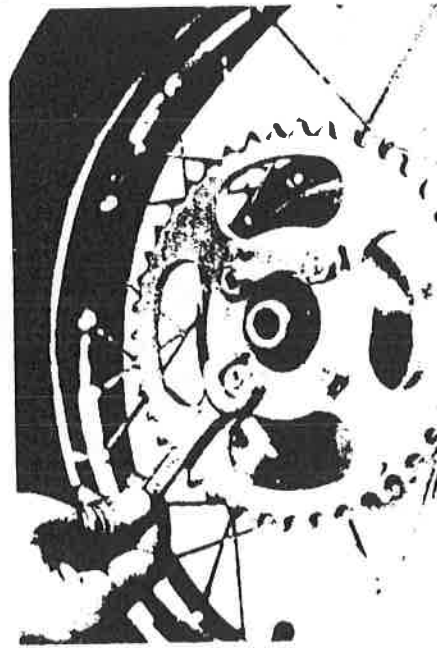

3. Check the lock washer and fitting bolt for breakage and damage. If the lock washer is not bent over the fitting bolt head, or is broken, or if the bolt is loose, the sprocket can come loose. Make sure that both lock washers and the mounting bolts are tight when installing new sprocket.

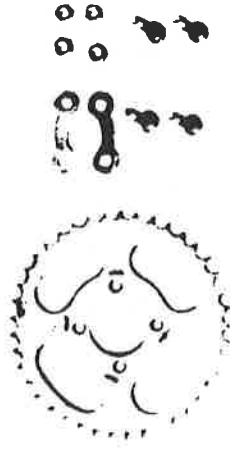

3. Checking Rims and Spokes
(Front & Rear Wheels)

1. Checking for loose spokes

Loose spokes can be checked by bracing the machine off the ground so that the wheel can spin free. Slowly revolve the wheel and at the same time let the metal shaft of a fairly heavy screwdriver bounce off each spoke. If all the spokes are tightened approximately the same then the sound given off by the screwdriver hitting the spokes should sound the same. If one spoke makes a dull flat sound, then check it for looseness.

2. Checking rim "run-out"

While you have the wheel elevated, you should check that it does not have too much run-out. "Run-out" is the amount the wheel deviates from a straight line as it spins. Spin the wheel, and solidly anchor some sort of a pointer about 1/8" away from the side of the rim. As the wheel spins, the distance between the pointer and the rim should not change more than 1/16" total. Any greater fluctuation means that you should have your dealer remove this rim warpage by properly adjusting the spokes.

LATERAL RUN-OUT LIMITS: 2mm 0.07" (1/16")
VERTICAL RUN-OUT LIMITS: 2mm 0.07" (1/16")

4. Tire Repairs

1. Removal
 1. Remove valve cap, valve core, and valve stem lock nut.
 2. When all air is out of tube, separate tire bead from rim (both sides) by stepping on tire with your foot.
 3. Use two tire removal irons (with rounded edges) and begin to work the tire bead over the edge of the rim, starting 180° opposite the tube stem. Take care to avoid pinching the tube as you do this.

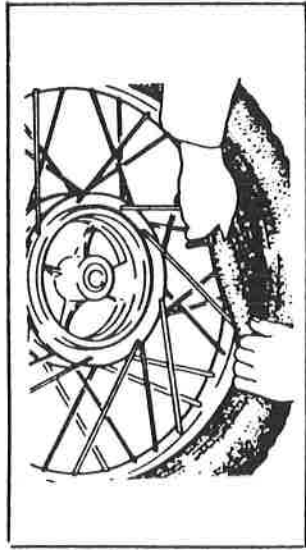
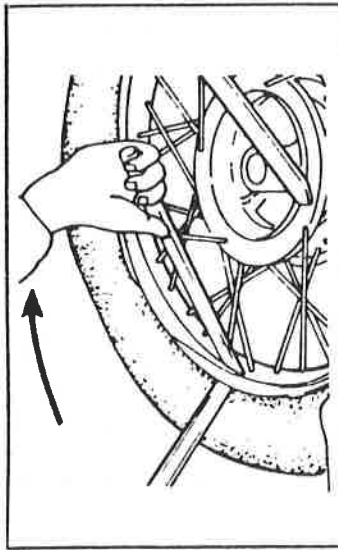

4. After you have worked one side of the tire completely off the rim, then you can slip the tube out. Be very careful not to damage the stem while pushing it back out to the rim hole.

NOTE: If you are changing the tire itself, the finish the removal by working then tire off the same rim edge just previously mentioned.

2. Installing Tire

Reinstalling the tire assembly can be accomplished by reversing the disassembly procedure. The only difference in procedure would be right after the tube has been installed, but before the tire has been completely slipped onto the rim, inflate the tube. This removes any creases that might exist. Release the air and continue with reassembly. Also, right after the tire has been completely slipped onto the rim, check to make sure that the stem is squarely in the center of the hole in the rim.

TIRE PRESSURE	Front	20 lbs/in ² (1.4 kg/cm ²)	Normal Riding (use 4 - 6 p.s.i. for max. traction at slow speeds)
	Rear	28 lbs/in ² (2.0 kg/cm ²)	

2. FRONT FORKS AND STEERING HEAD

1. General - The front forks on your machine utilize chrome plated tubular steel fork legs (inner tubes) and tubular aluminum sliders (outer tubes). The bearing surface is the entire inside surface of the aluminum outer tube.

The steering head pivot is supported by two sets of uncaged ball and race bearing assemblies.

2. Front Fork Oil Change

1. Remove cap bolts on inner fork tubes.
2. Remove drain screw from each outer tube with open container under each drain hole.
3. After most of oil has drained, slowly raise and lower outer tubes to pump out remaining oil.
4. Replace drain screws.

NOTE: Check gaskets, replace if damaged.

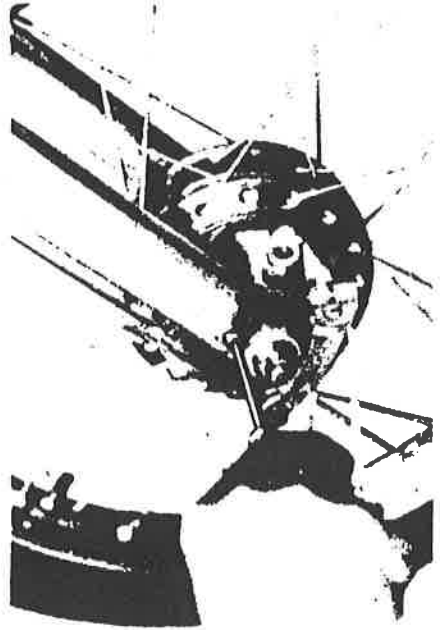

5. Measure correct amount of oil and pour into each leg.

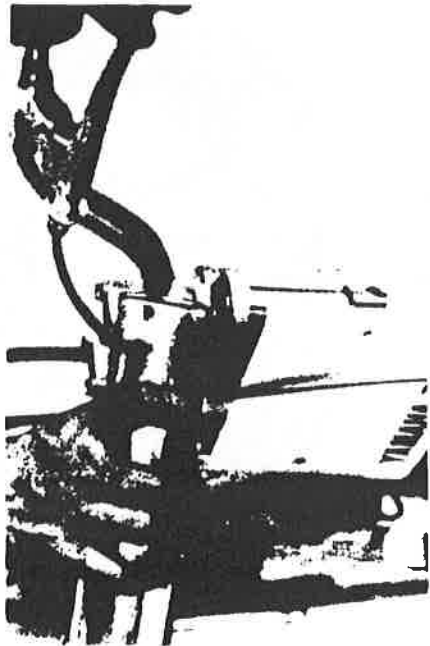

Recommended Oil: Non-foaming hydraulic fluid,
10, 20, 30wt. (fork oil)
Quantity: 85cc/2.9oz. (per leg)

NOTE: Select the weight oil that suits local conditions and your preference (lighter for less damping; heavier for more damping).

6. After filling, slowly pump the outer tubes up and down to distribute the oil.

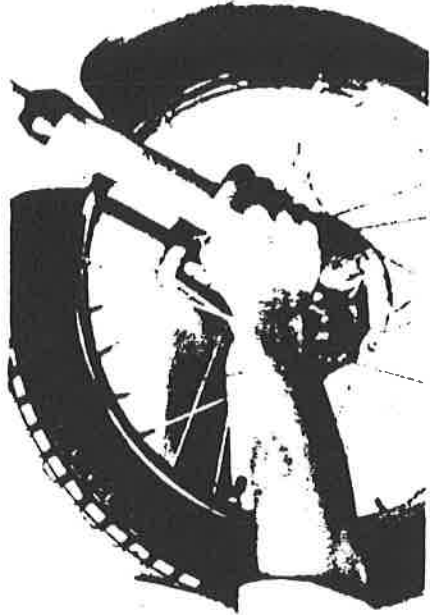

7. Inspect O-ring on inner tubes and replace if damaged.
8. Replace fork cap bolts and torque to specification.

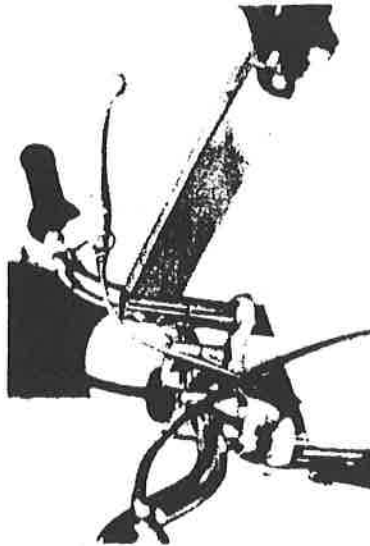

FORK CAP TORQUE: 3.5 - 4.0 kg-m
(300 - 350 in-lbs)

3. Front Fork Disassembly

1. With the front wheel removed, the fork legs can be removed from the upper and lower brackets.

2. Disassembly procedure for individual fork tube assembly is found in DT250A/360A Service Manual.

NOTE: Proper fork seal installation is important. Also, carefully tap seal in with large socket to avoid damage to aluminum fork tube.

4. Steering Head Adjustment

1. With front wheel elevated, grasp bottoms of fork legs and gently push and pull to check steering head freeplay. There should be no noticeable freeplay.

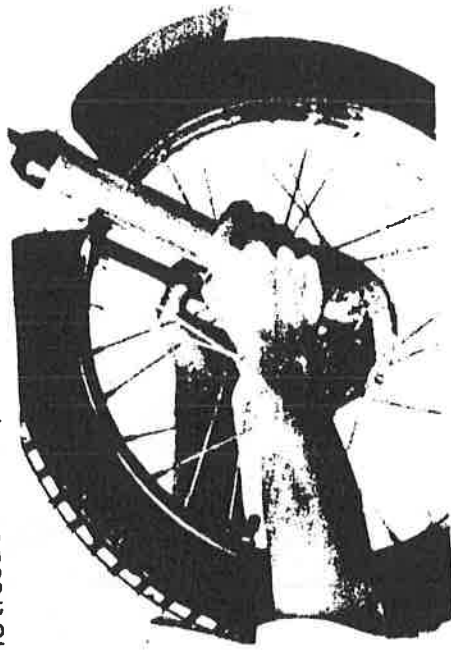

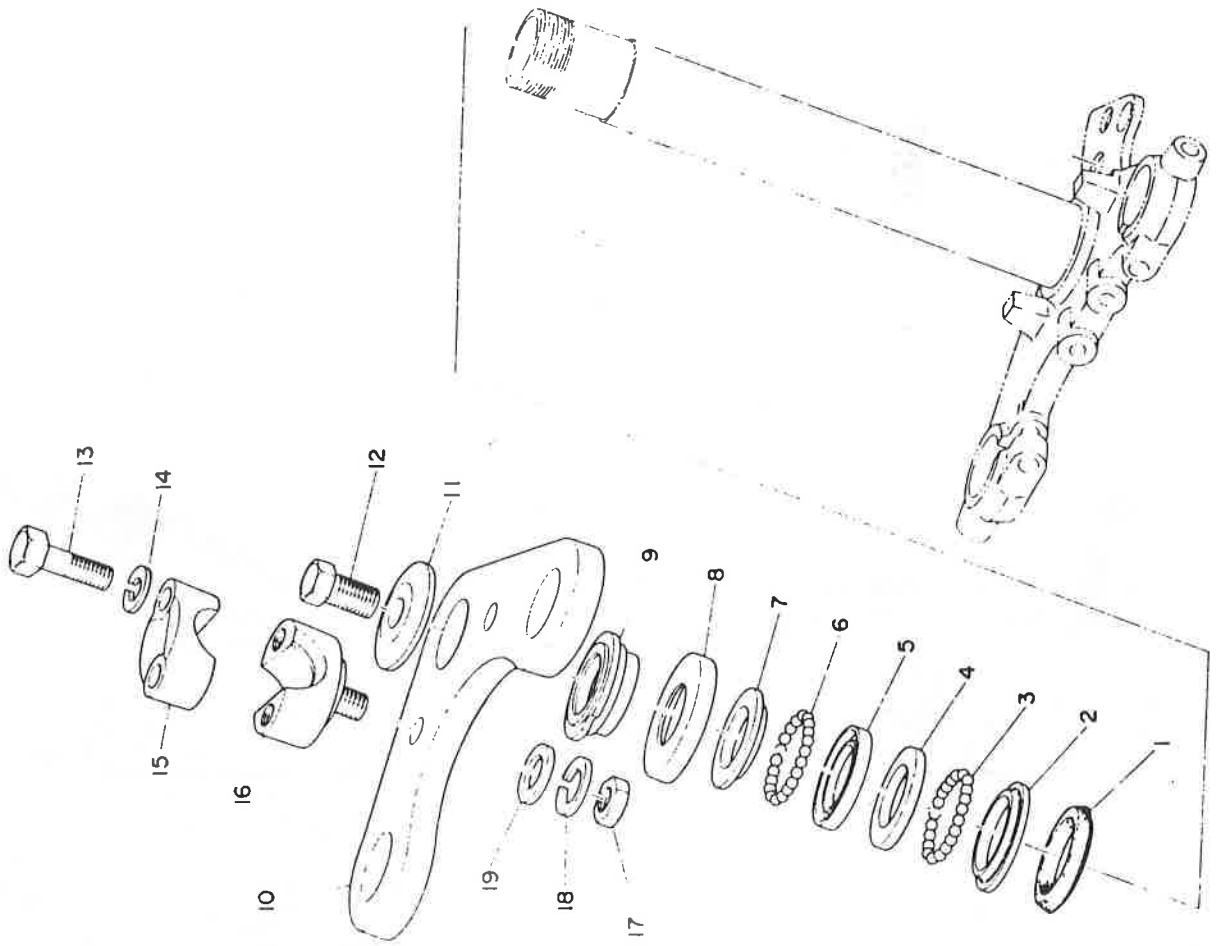

1. Dust seal 1
2. Ball race 1
3. Ball
4. Ball race 2
5. Ball race 2
6. Ball
7. Ball race 1
8. Ball race cover
9. Fitting nut
10. Handle crown
11. Crown washer
12. Fitting bolt
13. Bolt
14. Spring washer
15. Handle holder upper
16. Handle holder under
17. Nut
18. Spring washer
19. Plain washer

2. Loosen stem bolt.

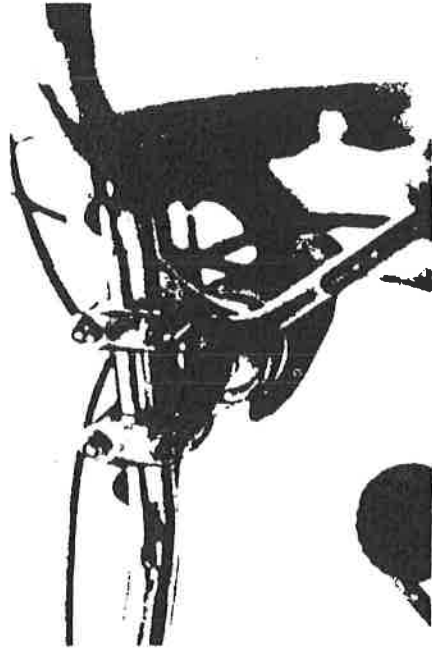

3. Use steering nut wrench to tighten adjust nut. Tighten until freeplay is eliminated.

CAUTION:

Forks must swing from lock to lock without binding or catching.



4. Tighten stem bolt and torque to specification.

STEM BOLT TORQUE:	3.5 - 4.0 kg-m (300 - 350 in-lbs)
-------------------	--------------------------------------

3. REAR SHOCK ABSORBERS AND SWING ARM

1. Rear Shock Removal and Inspection

1. After rear wheel has been removed, remove Phillip head screw, crown nut and cup washer from each shock.

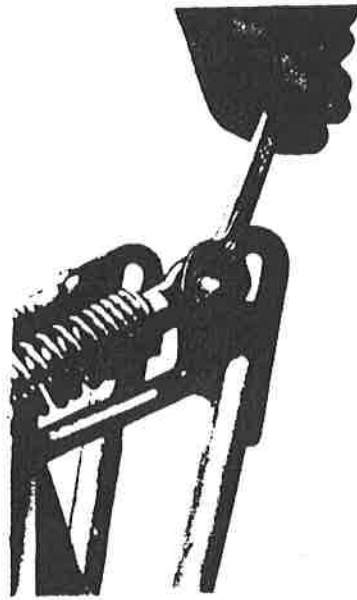

2. Remove shock.
3. Operate shock absorber to check damping. As you push down, only slight damping should be felt. Return stroke will have considerable damping. If there is no damping, replace shock.



2. Swing Arm Inspection

1. With rear wheel and shock absorbers removed, grasp the ends of the arm and move from right to left to check for freeplay.



Swing Arm Freeplay: 1.0mm 0.04in.

2. If freeplay is excessive, remove swing arm and replace swing arm bushings.

CHAPTER X ELECTRICAL SYSTEM

1. GENERAL INFORMATION AND SCHEMATICS

1. General

1. The TY80A uses a flywheel magneto to generate electrical current/voltage for the ignition system and the lighting system. There are two coils attached to the magneto backing plate. The righthand coil supplies primary voltage to the ignition coil. The left-hand coil provides alternating current (A.C.) for operation of the lights and horn.

NOTE: If headlight filament burns out while engine is running, the tail lamp filament may also burn out because of excess voltage. Always check taillight operation when replacing headlight.

2. Table of Component Parts

PART NAME	MANUFACTURER	MODEL/TYPE
Flywheel Magneto	MITSUBISHI	FOT00173Z
Ignition Coil	HITACHI	CM61-20M
Contact Breaker Ass'y	HITACHI	
Condenser	HITACHI	
Spark Plug	N.G.K.	B-6HS

3. Electrical Wiring Diagram

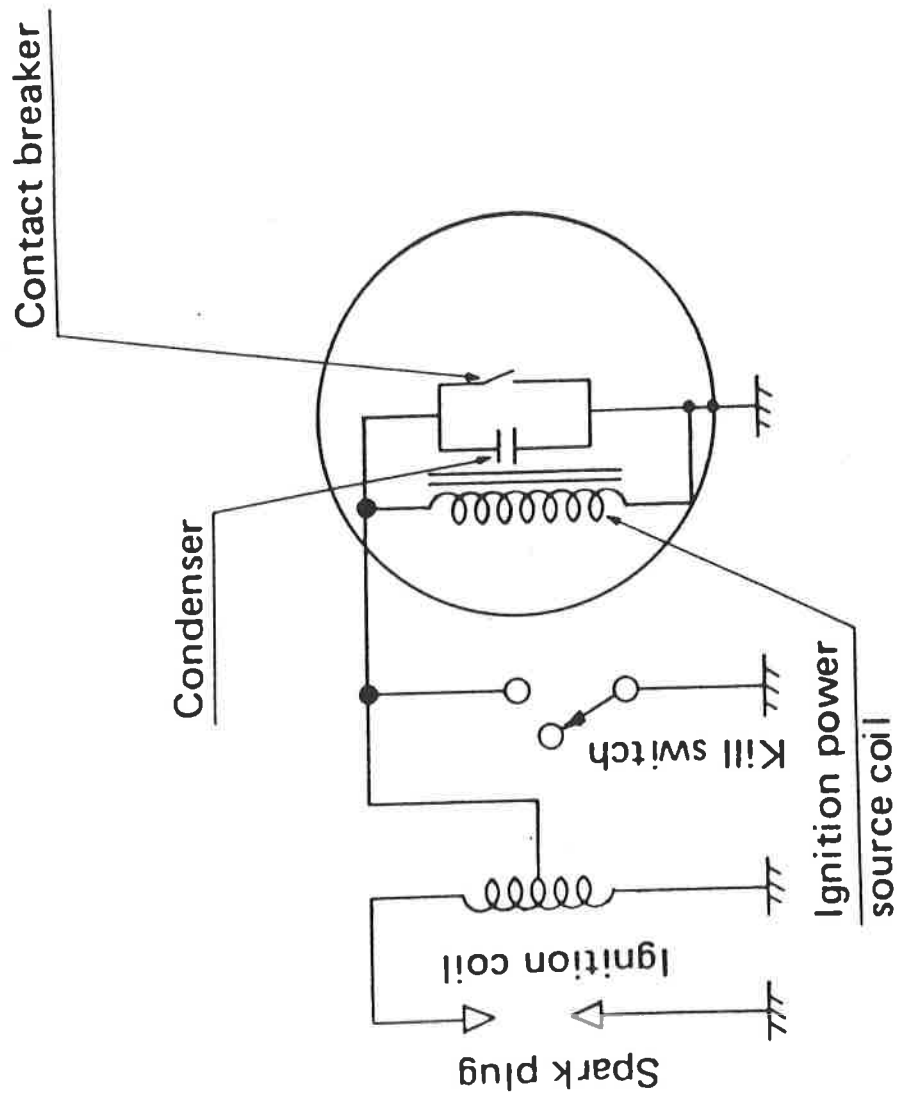

2. Magneto Ignition System

1. Description

The ignition system consists of the following parts:

1. Flywheel magneto
2. Ignition source coil
3. Contact breaker assembly (points)
4. Ignition condenser
5. Ignition coil (voltage step-up coil)
6. Kill button
7. Spark plug

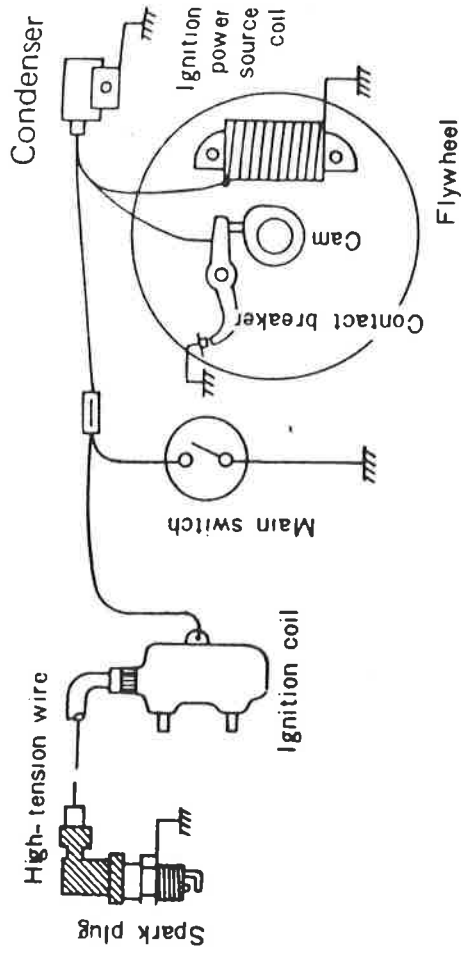

As the flywheel rotates, the contact breaker points begin to open and close, alternately. This make-and-brake operation develops an electromotive force in the ignition power source coil, and produces a voltage in the ignition coil primary windings. The ignition coil is a kind of transformer, with a 1:50 turn ratio of the primary to the secondary winding. The voltage (150-300V) which is produced in the primary coil, is stepped up to 12,000-14,000V by mutual-induction and the electric spark jumps across the spark plug electrodes.

2. Ignition Timing

Refer to "Mechanical Adjustments, Ignition Timing" for step-by-step procedure.

Spark Test:

Remove the spark plug from the cylinder head and reconnect the high voltage lead. Then hold the spark plug approximately 7mm away from the head and see if it sparks as you crank the kickstarter. If it sparks at 7mm, or so, and has blue white color, the ignition coil should be considered to be in good condition.

3. Ignition Coil

Primary coil res. $1.7 \Omega + 10\%$ (20°C or 68°F)
Secondary coil res. $6.0 \text{ K}\Omega + 10\%$ (20°C or 68°F)

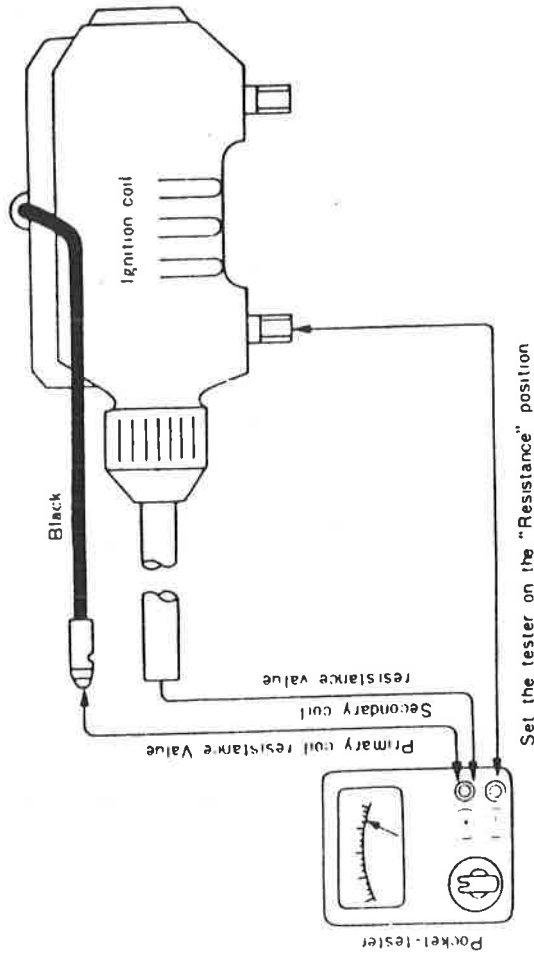

Burned contact points greatly affect the flow of current in the primary winding of the ignition coil. If the contact points show excessive wear, or the spark is weak (the ignition coil is in good condition), check the condenser.

4. Condenser

The condenser instantly stores a static electric charge as the contact breaker points separate, and the energy stored in the condenser discharges instantly when the points are closed. If it were not for the condenser, an electric arc would jump across the separating contact points causing them to burn.

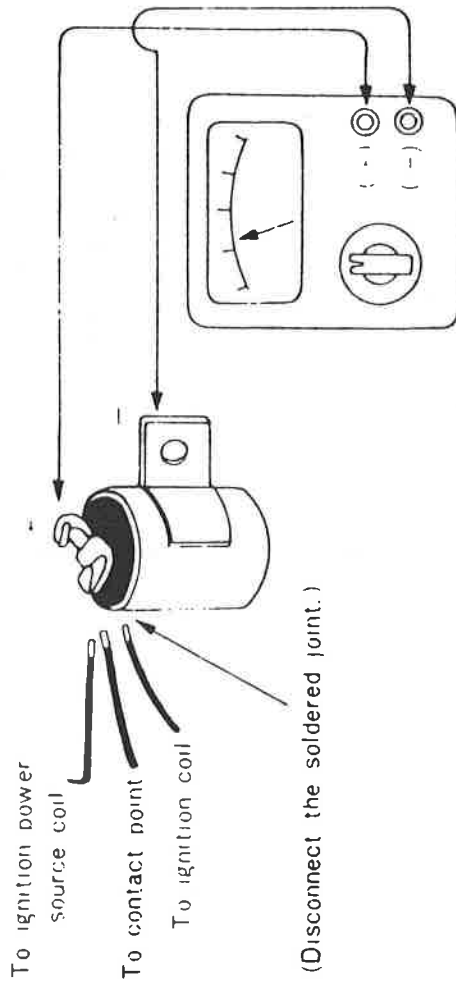

Set the tester on the "MΩ" position.

Insulation resistance tests should be conducted by connecting the tester as shown. If the pointer swings fully and the reading is more than $3M\Omega$, the insulation is in good condition.

If the insulation is faulty, the pointer will stay pointing at the uppermost reading, indicating very little resistance.

NOTE: After this measurement, the condenser should be discharged by connecting the positive and negative sides with a thick wire.

Capacity tests can be performed by simply setting the tester to the condenser capacity. The tester should be connected with the condenser in the same way as in the case of the insulation resistance test. Before this measurement, be sure to set the tester correctly. If the reading is within $0.3\mu F + 10\%$, the condenser capacity is correct.

CHAPTER XI MISCELLANEOUS

CONVERSION TABLES

LENGTHS

Multiply	By	To Obtain	Multiply	By	To Obtain
Millimeters (mm)	0.03937	Inches	Kilometers (km)	0.6214	Miles
Inches (in)	25.4	Millimeters	Miles (mi)	1.609	Kilometers
Centimeters (cm)	0.3937	Inches	Meters (m)	3.281	Feet
Inches (in)	2.54	Centimeters	Feet (ft)	0.3048	Meters

WEIGHTS

Kilograms (kg)	2.205	Pounds	Grams (g)	0.03527	Ounces
Pounds	0.4536	Kilograms	Ounces (oz)	28.25	Grams

VOLUMES

Cubic centimeters (cc)	0.06102	Cubic inches	Imperial gallons	277.274	cu.in.
Cubic inches (cu.in.)	16.387	cc.	Liters (l)	1.057	Quarts
Liters (l)	0.264	Gallons	Quarts (qt)	0.946	Liters
Gallons (gal)	3.785	Liters	Cubic centimeters (cc)	0.0339	Fluid ounces
U.S. gallons	1.2	Imperial gals.	Fluid ounces (fl.oz.)	29.57	cc.
Imperial gallons	4.537	Liters			

OTHERS

Metric horsepower (qs)	1.014	bhp	Foot-pounds (ft-lbs)	0.1383	kg-m
Brake horsepower (bhp)	0.9859	ps.	Kilometers per liter	2.352	mph
Kilogram-meter (kg-m)	7.234	Foot-pounds	(km/l)		
Kilograms/sq.cm	14.22	Pounds/sq.in.	Miles per gallon (mpg)	0.4252	km/l
		(Lbs/in ² or psi)			
Centigrade (C°)	(C° x 9/5) + 32	Fahrenheit (F°)			

Inches to Millimeters

0	0.01	0.02	0.03	0.04	0.05	0.06	0.07	0.08	0.09
0	0.254	0.508	0.762	1.016	1.270	1.524	1.778	2.032	2.286
0.1	2.794	3.048	3.302	3.556	3.810	4.064	4.318	4.572	4.826
0.2	5.334	5.588	5.842	6.096	6.350	6.604	6.858	7.112	7.366
0.3	7.874	8.128	8.382	8.636	8.890	9.144	9.398	9.652	9.906
0.4	10.414	10.668	10.922	11.176	11.430	11.684	11.938	12.192	12.446
0.5	12.954	13.208	13.462	13.716	13.970	14.224	14.478	14.732	14.986
0.6	15.494	15.748	16.002	16.256	16.510	16.764	17.018	17.272	17.526
0.7	18.034	18.288	18.542	18.796	19.050	19.304	19.558	19.812	20.066
0.8	20.574	20.828	21.082	21.336	21.590	21.844	22.098	22.352	22.606
0.9	23.114	23.368	23.622	23.876	24.130	24.384	24.638	24.894	25.146
1.0	25.654	25.908	26.162	26.416	26.670	26.924	27.178	27.432	27.686

0.001"=0.0254mm 0.003"=0.0762mm 0.005"=0.1270mm 0.007"=0.1778mm 0.009"=0.2286mm
 0.002"=0.0508mm 0.004"=0.1016mm 0.006"=0.1524mm 0.008"=0.2032mm 0.010"=0.254mm

Millimeters to Inches

	0	0.1	0.2	0.3	0.4	0.5	0.6	0.7	0.8	0.9
0		0.0039	0.0079	0.0018	0.0157	0.0197	0.0236	0.0276	0.0315	0.0354
1	0.0394	0.0433	0.0472	0.0512	0.0551	0.0591	0.0630	0.0669	0.7099	0.0748
2	0.0787	0.0827	0.0866	0.0906	0.0945	0.0984	0.1024	0.1063	0.1102	0.1142
3	0.1181	0.1200	0.1260	0.1299	0.1339	0.1378	0.1417	0.1457	0.1496	0.1535
4	0.1575	0.1614	0.1654	0.1693	0.1732	0.1772	0.1811	0.1850	0.1890	0.1929
5	0.1969	0.2000	0.2047	0.2087	0.2126	0.2165	0.2205	0.2244	0.2283	0.2323
6	0.2362	0.2402	0.2441	0.2480	0.2520	0.2559	0.2598	0.2638	0.2677	0.2717
7	0.2756	0.2795	0.2835	0.2874	0.2913	0.2953	0.2992	0.3031	0.3071	0.3110
8	0.3150	0.3189	0.3228	0.3268	0.3307	0.3346	0.3386	0.3425	0.3465	0.3504
9	0.3542	0.3583	0.4016	0.3661	0.3701	0.3740	0.3780	0.3819	0.3858	0.3898
10	0.3937	0.3976	0.4016	0.4055	0.4094	0.4134	0.4173	0.4213	0.4252	0.4291

0.01mm=0.004 0.03mm=0.0012 0.05mm=0.0020 0.07mm=0.0028 0.09mm=0.0035
 0.02mm=0.008 0.04mm=0.0016 0.06mm=0.0024 0.08mm=0.0031 0.10mm=0.0039

CLEANING AND STORAGE

A. Cleaning

Frequent thorough cleaning of your motorcycle will not only enhance its appearance but will improve general performance and extend the useful life of many components.

1. Before cleaning the machine:
 - a. Block off end of exhaust pipe to prevent water entry; a plastic bag and strong rubber band may be used.
 - b. Remove air cleaner or protect it from water with plastic covering.
 - c. Make sure spark plug(s), gas cap, oil tank cap, transmission oil filler cap and battery caps are properly installed.
2. If engine case is excessively greasy, apply degreaser with a paint brush. Do not apply degreaser to chain, sprockets, or wheel axles.
3. Rinse dirt and degreaser off with garden hose, using only enough hose pressure to do the job. Excessive hose pressure may cause water seepage and contamination of wheel bearings, front forks, brake drums, and transmission seals. Many expensive repair bills have resulted from improper high-pressure detergent applications such as those available in coil-operated car washes.
4. Once the majority of dirt has been hosed off, wash all surfaces with warm water and mild, detergent-type soap. An old tooth brush or bottle brush is handy to reach those hard-to-get-to places.
5. Rinse machine off immediately with clean water and dry all surfaces with a chamois skin, clean towel, or soft absorbent cloth.
6. Immediately after washing, remove excess moisture from chain and lubricate to prevent rust.
7. Chrome-plated parts such as handlebars, rims, spokes, forks, etc., may be further cleaned with automotive chrome cleaner.
8. Clean the seat with a vinyl upholstery cleaner to keep the cover pliable and glossy.
9. Automotive-type wax may be applied to all painted and chrome-plated surfaces. Avoid combination cleaner-waxes. Many contain abrasives which may mar paint or protective finish on fuel and oil tanks.
10. After finishing, start the engine immediately and allow to idle for several minutes.

B. Storage

Long term storage (30 days or more) of your motorcycles will require some preventive procedures to insure against deterioration. After cleaning machine thoroughly, prepare for storage as follows:

1. Drain fuel tank, fuel lines, and carburetor float bowl(s).
2. Remove empty fuel tank, pour a cup of 10W to 30W oil in tank, shake tank to coat inner surfaces thoroughly and drain off excess oil. Reinstall tank.
3. Remove spark plug, pour about one tablespoon of 10W to 30W oil in spark plug hole and reinstall spark plugs. Kick engine over several times (with ignition off) to coat cylinder walls with oil.
4. Remove drive chain. Clean thoroughly with solvent and lubricate with graphite-base chain lubricant. Reinstall chain or store in a plastic bag (tie to frame for safe-keeping).
5. Lubricate all control cables.
6. Remove battery and charge. Store in a dry place and re-charge once a month. Do not store battery in an excessively warm or cold place (less than 32°F or more than 90°F).
7. Block up frame to raise both wheels off ground. (Main stands can be used on machines so equipped.)
8. Deflate tires to 15psi.
9. Tie a plastic bag over exhaust pipe outlet(s) to prevent moisture entering.
10. If storing in humid or salt-air atmosphere, coat all exposed metal surfaces with a light film of oil. Do not apply oil to rubber parts or seat cover.

CABLE ROUTING DIAGRAMS

